

■ ■ wissner-
■ ■ bosserhoff

Functional elegance in nursing care



movita | movita casa

Nursing home beds





movita – the entry model

Cost-effective, comfortable, individual

Cost-effective in nursing care and comfortable for the patient – the movita and movita casa nursing home beds present themselves as a resident room solution for institutions that are budget-oriented, yet have high standards in terms of coziness and quality. The low bed height of 37 cm makes it easy to get into and out of bed comfortably, even for smaller residents, and facilitates transfer to a chair. The nursing staff saves time, as movita and movita casa can be moved and braked in any position.

movita

The mobile entry model



movita casa

The cozy entry model





Our standards – for your benefit

Focus on the user

With its products and service portfolio, wissner-bosserhoff pursues the objective of sustainably enhancing customer benefits. The focus of product development includes functional benefits with technological innovations as well as the added aesthetic value derived from the choice of nursing bed design options. You benefit in several ways: The resident's independence is maintained, routine nursing tasks are simplified, maintenance requirements are reduced and the economic efficiency of the operator is increased.



The movita portfolio

The models at a glance

Bed model	movita The mobile entry model	movita casa The cozy entry model
Movability	In the resident's room and in corridors In every bed height Visible 100/125 mm castors	In the resident's room In every bed height Cozy undercarriage cladding
Braking capacity	Central brake at the foot end	A brake for each axle

Your movita benefits

Overview

- Outstanding cost-benefit ratio
- Individual height adjustment of 36 (38) - 78 (80) cm with movita, 37-79 cm with movita casa
- Investment security:
 - Max. resident weight up to 190 kg
 - Integrated bed extension
 - Minimum accessory requirements
- Individual mobilization of residents with divided side guards
- Bedsore prevention
- Time savings in nursing care

The WIBO promise

 <p>Resident</p> <ul style="list-style-type: none"> • High level of safety • Prolonged independence • Effective fall and bedsore prevention 	 <p>Nursing care</p> <ul style="list-style-type: none"> • Maximum time savings • Barrier-free access to the resident • Reduction of back strain when working
 <p>Management</p> <ul style="list-style-type: none"> • Excellent cost/benefit ratio • Maximum utilization thanks to high level of resident satisfaction • Minimum follow-up costs 	 <p>Maintenance / technology</p> <ul style="list-style-type: none"> • Tailor-made service concepts • Low maintenance costs • Optimum availability of spare parts

Patient surface with BiNetic frame

Patient surface concept for bedsore prevention

If persons are confined to bed, their care requirements change. Mobilization of the person being cared for becomes more important in order to avoid the development of bedsores. With the BiNetic frame, movita supports active mobilization by the nursing staff with a patient surface that effectively minimizes friction and shearing forces. The simultaneous retraction of the backrest and legrest demon-

strably reduces friction and shearing forces. The ergonomic division of the modular patient surface additionally contributes to the prevention of bedsores. For further reduction of pressure forces, the (optional) express bed extension can be used, which prevents the legs of tall residents from hitting the foot end of the bed when adjusting the backrest.

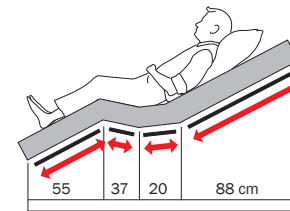

movita patient surface 200 cm with BiNetic frame

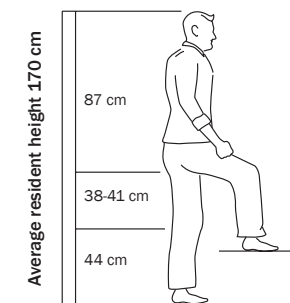

Patient surface ergonomics

The dimensions of the 4-part patient surface of wissner-bosserhoff nursing home beds are based on anthropometric findings, i.e. on the average size and height of a person. These

findings demonstrate that the backrest needs to be at least 80 cm long to effectively support the cervical spine.*

Patient surface modularity

You can choose between 3 different patient surface options:

- The wire mesh patient surface **Aero (01)** ensures good aeration.
- The synthetic mats of the **Easyclean surface (02)** are especially easy to clean.
- The **comfort patient surface (03)** with its outstanding **soft positioning properties (a)**, supports bedsore prevention.

In general, the patient surface partitions can be easily removed and cleaned (b).

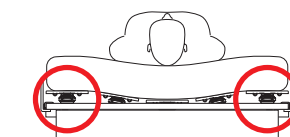

a

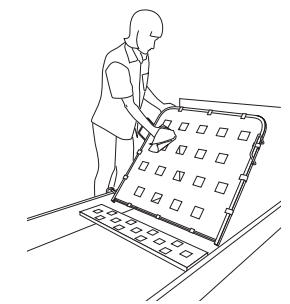

b

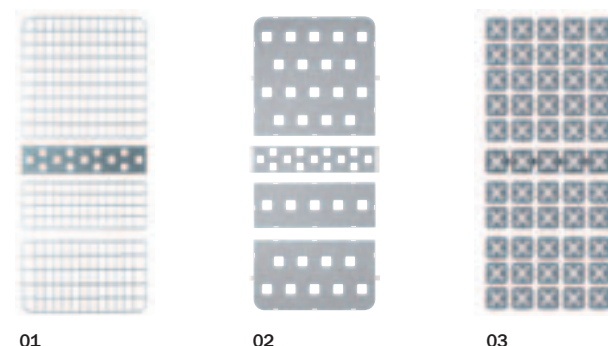

01

02

03

* cf. Eigler, F.W.: Arzt und Krankenhaus (doctor and hospital) 7, 1989

Effectiveness of double retraction confirmed

For years now, wissner-bosserhoff has been pursuing a practicable concept for reducing the risk of bedsores: the double retraction as a component of the BiNetic frame patient surface. In single retraction, raising the head end is not merely done by bending it like a hinged joint, the head end section of the bed is shifted away from the central section. This means that the bed sections are moved "away from each other" (see fig. 2b). On the one hand, this significantly reduces the pressure on the sacral region; on the other, the central section surface is enlarged. This is of benefit to the sitting resident, since the seating surface is enlarged, additionally reducing the pressure. In case of the double retraction, not only the head end section is moved, but the foot end section is additionally shifted away from the central section, increasing the seating surface even more. In the meantime, findings of pressure measurements clearly demonstrate that single retraction reduces the pressure level compared to a standard head section. In double retraction (fig. 3b), the pressure is even lower than with a single retraction.

Fig. 1

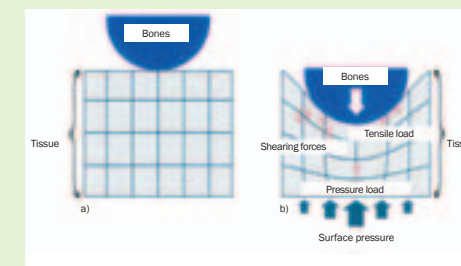

Fig. 2

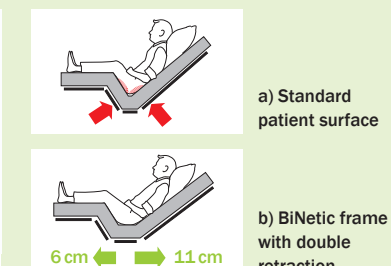
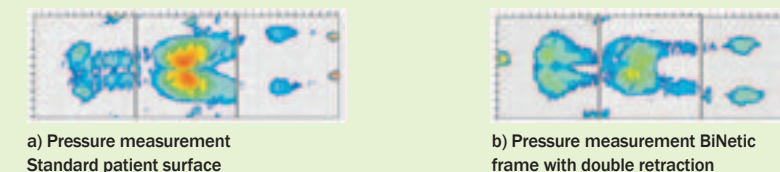

Fig. 3



a) Pressure measurement Standard patient surface

b) Pressure measurement BiNetic frame with double retraction

Of course, double retraction is not to be considered as the only means of bedsore prophylaxis. It can, however, effectively support existing options and, above all, demonstrates that we should make use of all technical means at hand to improve nursing care.

Source: Gerhard Schröder, wound care expert from Göttingen, respect magazine, edition 8/2011, page 16-17

Resident

- Reduced pressure in the pelvic area as well as reduced friction and shearing forces
- Ergonomic patient surface division for increased comfort
- Excellent support of the head when adjusting the backrest

Nursing care

- More effective bedsore prevention
- The resident does not "slip down" the bed as much
- Less repositioning, more time for nursing tasks

Management

- Reduced bedsore risk and lower follow-up costs
- Time savings thanks to express bed extension
- For residents up to 175 cm in height, there is no need for a patient surface extension that would take up space
- Reduced need of stocking up on patient surface extensions

Maintenance / technology

- Quicker access to the motor
- Easy-to-clean patient surface

SafeFree

The concept for safety, independence and mobilization

4 side guards

1

In lowered position, the divided side guards, in addition to a cozy look, enable unhindered access to the resident for daily nursing tasks, changing wound dressings or making the bed. No need to take off and store interfering accessories like a middle post or fixed side guards.

4-stage extension

No protection needed



4 advantages

Free of barriers

no middle post and no central gap protector

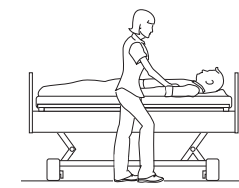

2

For safety at night, it is often sufficient to combine the low position of the bed with the first height level of the head-end side guard. This "soft protection" avoids unnecessary barriers and sustainably reduces the risk of falls. The side guards provide the resident with orientation without restriction.

Soft protection

without freedom-depriving measures (FDM)



Orientation

instead of FDM

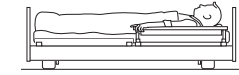

3

The 3/4 protection creates a deliberate bed egress gap at the foot end for the reduction of freedom-depriving measures (FDM), while at the same time maintaining the same high safety standard. By adjusting the bed and side guard height, movita/movita casa can be adapted to residents of every size and height.

3/4 protection

without FDM



Mobilization

with adaptation to resident height

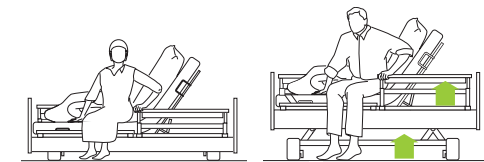

4

The third height level is used to comprehensively secure the resident in bed. In the top position, the two parts of the side guard close together so tightly that they are just as safe as a continuous side guard. Stocking up on accessories for closing a central gap when using an abdominal belt for restraining the patient is not necessary.

Full protection

for mattress heights from 12 to 18 cm



Safety

exceeding the requirements of the new standard IEC 60601-2-52

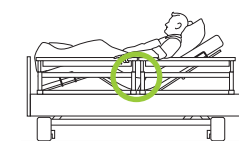

4 divided side guards create all-round access for nursing tasks

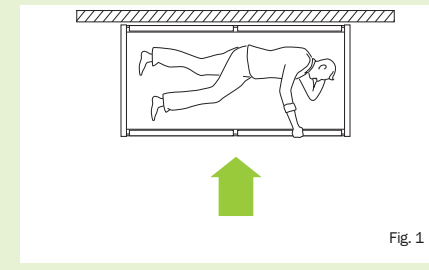

Fig. 1

Standard care – access from one side is sufficient

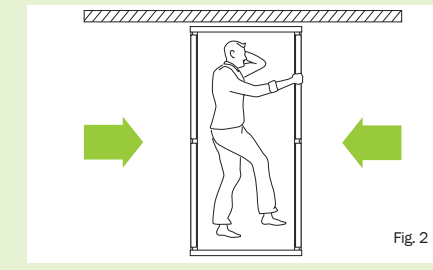

Fig. 2

Increased need for care – access from both sides needed

Your advantages:

1. Flexible use of the bed for standard care, even in limited spaces (fig. 1)
2. Flexible access from both sides of the bed in case of increased need for care (fig. 2)
3. Flexible use of the bed for bed egress on the left or right side to mobilize the resident
4. Follow-up costs for upgrading the bed with divided side guards are avoided

More safety thanks to small central gap* < 60 mm

- Targeted compliance with the new standard IEC 60601-2-52
- Safety in the working position, i.e. even with raised backrest or leg rest.
- Safety without using an additional central gap protector as accessory for fixation with abdominal belt in accordance with the BfArM (German Federal Institute for Drugs and Medical Devices) recommendations**



CB certificate on IEC 60601-2-52 from TÜV Hannover certification office

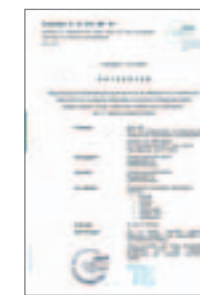

Certificate for the central gap issued by BerlinCERT

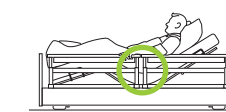

Compliance with IEC 60601-2-52 with central gap < 60 mm in the working position without central gap protector as an accessory

* Central gap = distance between the divided side guards

** Information for specialists from the BfArM (German Federal Institute for Drugs and Medical Devices), dated 07/08/2004 (reference No. 913/0704)



Resident

- Protection in every position
- Independent mobilization from the bed
- As much safety as possible, as much protection as needed



Nursing care

- Independent resident mobilization
- Suitable for all methods of positioning
- Legal security without having to comply with additional requirements
- Efficient use of restraining belts



Management

- Economic side guard solution – no additional costs for central gap protectors
- Certification acc. to new standard IEC 60601-2-52 creates investment security
- Cozy appearance, "like at home"



Maintenance / technology

- Smooth-operating, low-maintenance side guards
- No stocking up on accessories like central gap protectors or middle posts

Intelligent design handset

with extended functionality

The handset of movita/movita casa nursing - home beds impresses at first glance, thanks to its clear structure and ergonomic design: fewer buttons and large symbols facilitate intuitive operation.

The pre-selection function makes the handset initial fault tolerant – triggering – a function by accidentally pressing a key is not possible.

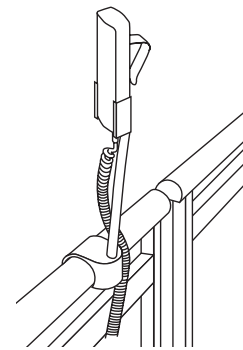

The handset is easy to reach for both the resident and staff at all times (accessory handset holder, model No. 10-0419 and 10-0421).

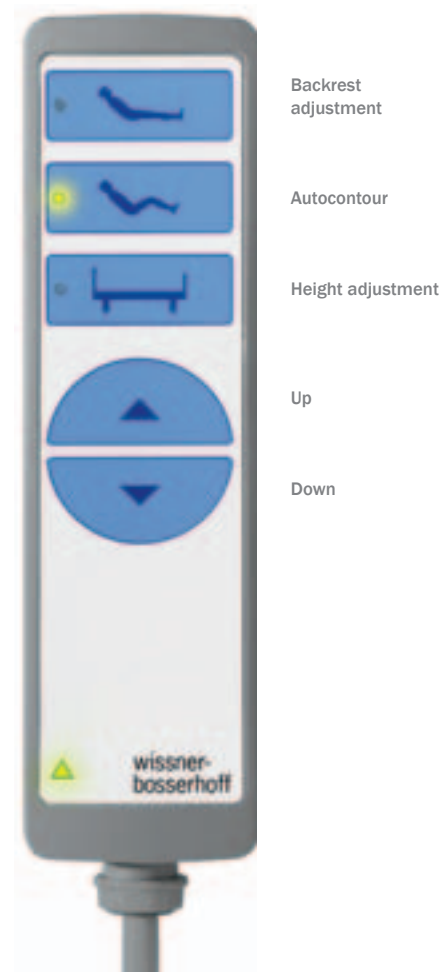

3 safety levels

Integrated into the handset rear side is the locking function, eliminating the need to search for a control box at the patient surface panel or to bend down.

With a magnet free key, the three handset modes can be set by adapting the adjustment options of the bed to fit the nursing care task. In **lock mode**, all functions of the handset are locked. In **resident and nursing mode**, the upper three buttons are available to the resident.



Resident

- User-friendly concept with clearly arranged symbols
- Initial fault tolerance in accordance with the standard IEC 60601-2-52, with special resident mode
- Pre-selection function to avoid accidental adjustments



Nursing care

- Handset functionality can be individually set depending on the respective care situation (3 modes)
- No extra costs for additional control box



Management

- Initial fault tolerance is not optional but standard
- Handset and control box in one – no need for an additional control box



Maintenance / technology

- High-quality EPR cable protects from wire breakage and prevents unnecessary maintenance operations
- No subsequent installation of a control box necessary if the resident situation changes

3 bed lengths

Without central gap > 318 mm and without middle post

All wissner-bosserhoff nursing home beds are equipped with an integrated bed extension. With the **express bed extension** (fig. below/option), the movita **can be flexibly adjusted to different bed lengths** with divided side guards. The requirements of the new standard IEC 60601-2-52 are complied with in each configuration.

200 cm

Bed length of 200 cm: The divided side guards offer protection without a central gap > 318 mm* and without a protector.

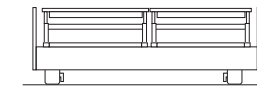

210 cm

Bed length of 210 cm: Protection with longer foot-end side guards without accessories and without a gap > 318 mm**.

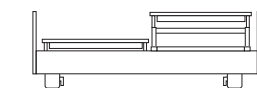

220 cm

Bed extension to 220 cm: Can be temporarily adjusted if needed – comprehensive protection ensured by foot-end protector (accessory).



* Central gap (distance between the divided side guards) < 60 mm

** Gaps between the divided side guards as well as between the side guards and the head and foot sections < 60 mm



Resident

- The highest possible safety standards for side guards; for all bed lengths
- Individual and quick bed length adjustment
- Individual mobilization possible



Nursing care

- Quick adjustment to different resident heights
- Working safely and efficiently
- Reduced risk when falling (FDM)
- Residents can mobilize themselves out of the bed
- Back-saving nursing height of 79 cm



Management

- Low follow-up costs thanks to working conditions that relieve stress on the back
- Low accessory costs for bed extension
- Bed extension tested and certified in accordance with IEC 60601-2-52



Maintenance / technology

- Quick conversion of the bed for tall residents
- Fewer replacement parts needed for bed extension

Effective cable management

D box provides energy for bed and reading light

With the convenient D box, the tangling of cables is a thing of the past. Attached at the inside of the head section, the D box collects both the cables of the bed and light. This way, only one cable leads to the power socket.

3 cables –
one solution –
many advantages

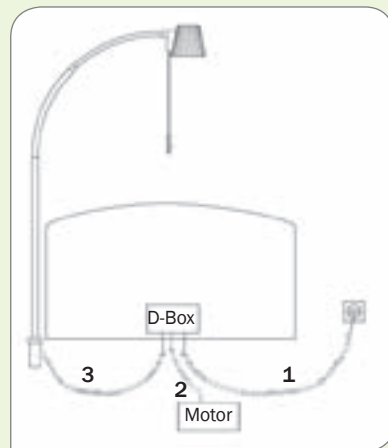

- You only have to pull out one single cable to be able to move the bed.
- No risk of mixing up cables when unplugging.
- Independent from the motor, therefore good access to the connectors in every bed position.
- For halogen and LED lights.

Halogen
and LED
technology

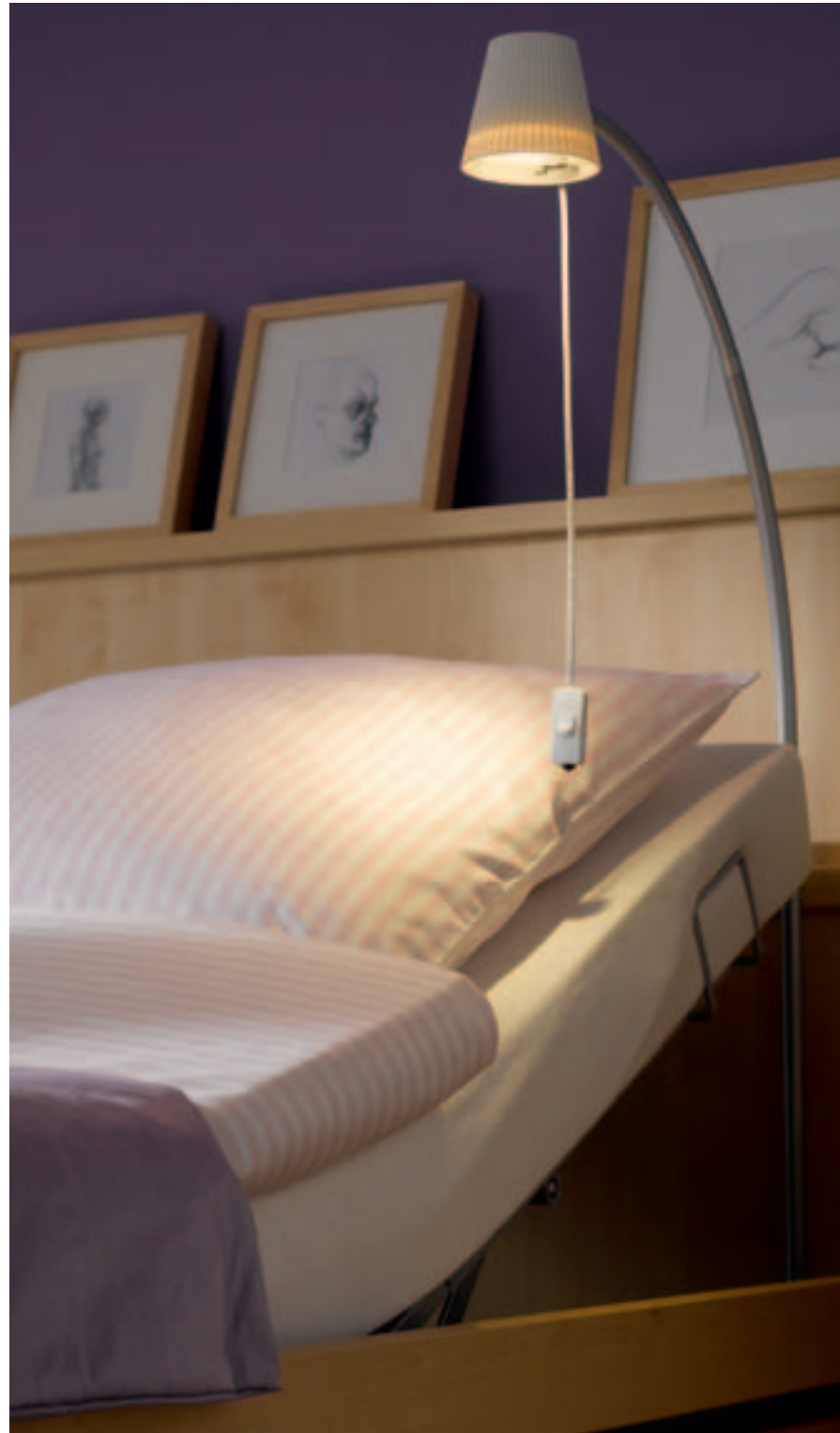

Safety and customer benefits

wissner-bosserhoff voluntarily has its production processes and management regularly audited by the TÜV*. The company is certified in accordance with the regulations of the standard DIN EN ISO 9001:2008 for quality management systems as well as DIN EN ISO 13485:2003+AC:2007 for the manufacture of medical devices.

Each nursing home bed is manufactured in accordance with the high standards of the German Law on Medical Devices (MPG) and carries the CE mark in accordance with the EU directive 93/42 EEC. Nursing home beds are certified and produced in accordance with the standard IEC 60601-2-52:2010-12. The recommendations of the BfArM (German Federal Institute for Drugs and Medical Devices), which exceed those requirements, are also incorporated into product development.

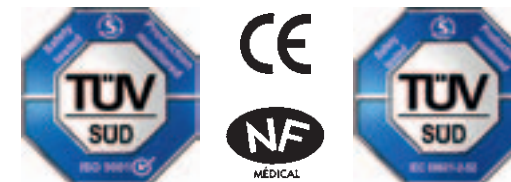
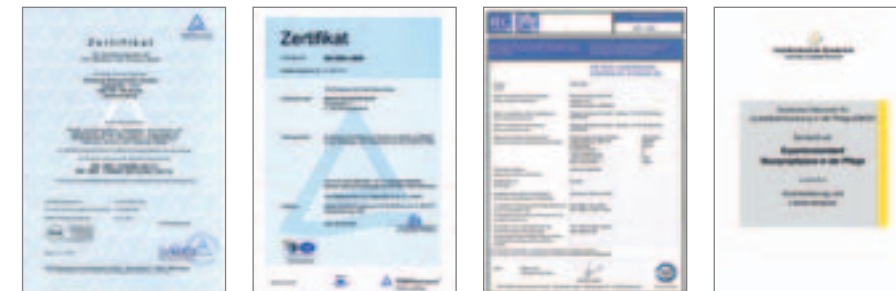

We place great value on your safety and long-term satisfaction in our products and services – for this reason, we gladly assist you at all times, from planning to the end of our nursing home beds' product life, and offer a matching service package for all phases.

* Definition TÜV: German Technical Inspection Authority

Design | Head and foot sections



Colors | Décors*



* Some décors available at extra charge

Furnishings and accessories

Dimensions for movita / movita casa (pictured: movita casa)

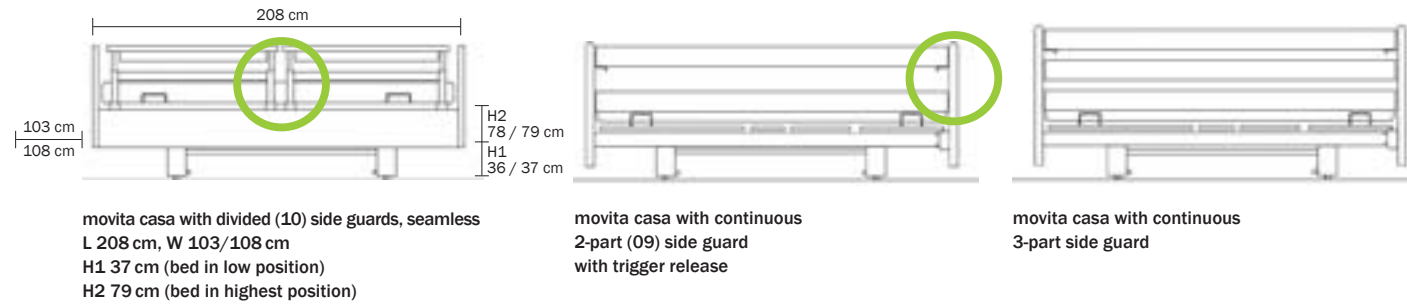

Patient surfaces

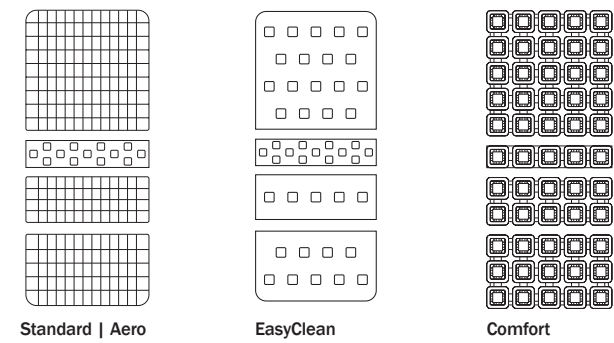

Bed extensions

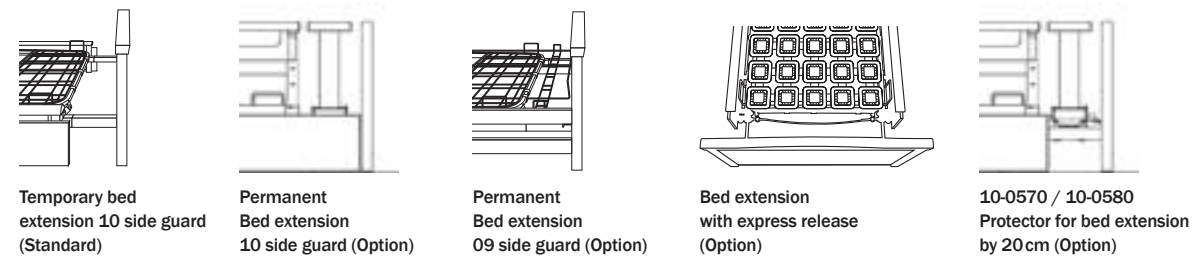

Options

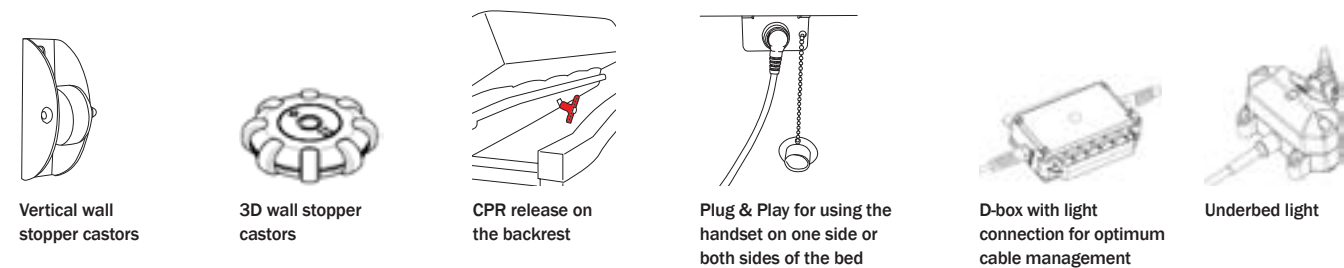

Accessories

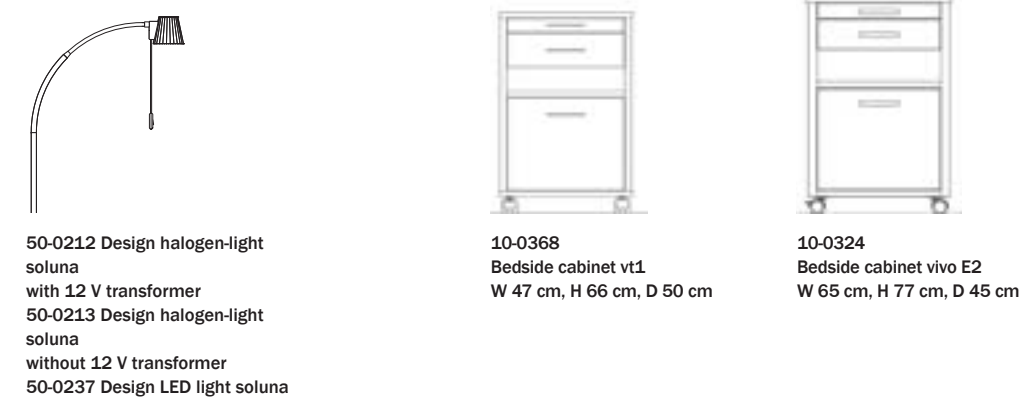
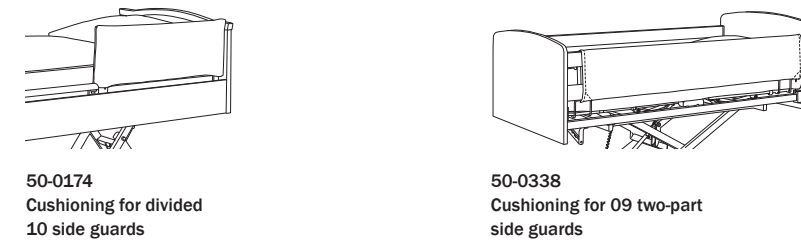
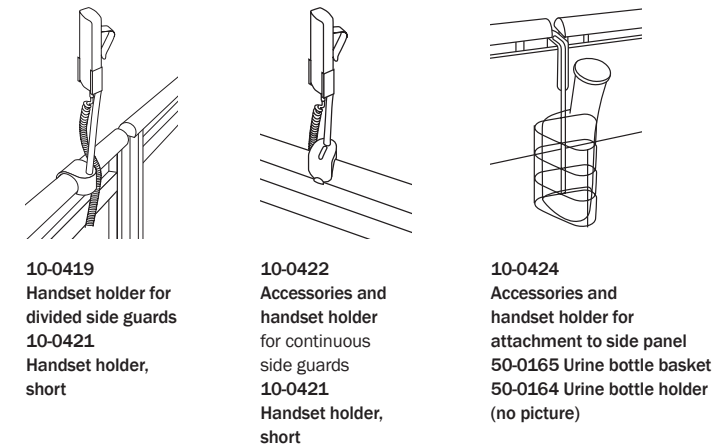



wissner-
bosserhoff

Functional elegance in nursing care

wissner-bosserhoff GmbH
Hauptstraße 4-6
D-58739 Wickede (Ruhr)
Phone: +49(0)2377/784-0
Fax: +49(0)2377/784-163
E-Mail: info@wi-bo.de

www.wi-bo.com