

Manufacturer:

L I N E T spol. s r.o.
Želevčice 5
274 01 Slaný

Tel.: +420 312 576 111
Fax: +420 312 522 668

E-mail: info@linet.cz
<http://www.linet.com>
Service department: service@linetgroup.com

OptiCare

Integrated mattress replacement system for Eleganza 5 and Multicare

Author: L I N E T, s.r.o.
Related links: www.linet.com

D9U003VS0-0110

Version: 03
Publication Date: 2023-12

Copyright © L I N E T, s.r.o., 2023
Translation © L I N E T, s.r.o., 2023
All rights reserved.

All trademarks and brands are the property of the appropriate owners. The manufacturer reserves the right to changes in the contents of the instructions for use that relate to the product's technical regulations. It is for this reason that the contents of the instructions for use may indicate differences from the current manufacture of the product. Reproduction, also excerpts, only with prior permission of the publisher. Subject to changes due to technical developments. All technical data are rated data and are subject to construction and manufacturing tolerances.

Table of Contents

1 Symbols and Definitions	4	11 Putting into Service (only OptiCare for Multicare) ..	41
1.1 Warning Notices	4	11.1 Mattress Installation	42
1.1.1 Types of Warning Notices	4	11.2 SCU (System Control Unit)	43
1.1.2 Structure of Warning Notices	4	11.3 Replacing the mattress.....	43
1.2 Instructions	4	12 Manipulation (OptiCare for Multicare)	44
1.3 Lists.....	4	12.1 Manual CPR (during Transport or Power loss)	48
1.4 Patents and Trade Marks	5	12.2 Automatic CPR (Multicare with OptiCare)	49
1.5 Symbols on the Package (OptiCare)	6	12.3 Mattress Screen (Multicare with OptiCare)	50
1.6 Symbols and Labels on the Mattress (OptiCare)	7	12.4 OptiCare Mattress Controls (Multicare with OptiCare)	
1.7 Serial Labels with UDI (OptiCare)	10	51
1.7.1 Wash Label (mattress)	10	12.4.1 MATTRESS NOT CONNECTED	51
1.8 Acoustic signalisation (OptiCare)	10	12.4.2 MATTRESS IDENTIFICATION	51
1.9 Abbreviations	11	12.4.3 MATTRESS INFLATION	52
1.10 Definitions	11	12.4.4 MATTRESS PREPARED FOR PATIENT	52
2 Safety Instructions (only OptiCare for Eleganza 5) ..	12	12.4.5 PATIENT ON THE MATTRESS	53
3 Safety Instructions (only OptiCare for Multicare)	15	12.4.6 MAXIMUM MATTRESS INTERNAL PRESSURE ..	53
4 Intended use of OptiCare	18	12.4.7 PRESSURE COMFORT ADJUSTMENT	54
4.1 Indications	18	12.4.8 MCM MODE	54
4.2 User population of OptiCare	18	12.4.9 CPR MODE (CPR ACTIVATED)	55
4.3 Contraindications	18	12.4.10 SETTING	55
4.4 Operator	18	12.4.11 ALERTS	56
5 Product Description (OptiCare)	19	12.4.12 POP-UPs	59
5.1 Mattress Structure	20	13 Equipment	60
5.2 Cover	20	13.1 X-ray Pocket	60
5.3 Bottom Deck	20	13.2 Hercules ready OptiCare integrated mattress.....	61
5.4 Heel section	20	13.2.1 Mattress Cover Cleaning and Disinfection Instructions	
5.5 Safety Straps	20	(Dream Air MIOB-44CVR)	62
5.6 Transport Handles	21	14 Cleaning/Disinfection (OptiCare)	63
5.7 SCU (System Control Unit)	21	14.1 Routine Cleaning and Disinfection	63
5.7.1 FIRMWARE	21	14.2 Full Cleaning and Disinfection	64
6 Technical Specification (OptiCare)	22	14.3 Removing the Mattress Cover	64
6.1 Mechanical Specifications	22	14.4 Machine Washing (Hi-MVP Slippy Mattress Cover)..	65
6.2 Environment conditions	22	15 Troubleshooting (OptiCare)	66
6.3 Electrical Specifications	22	16 Maintenance (OptiCare)	67
6.4 Electromagnetic Compatibility	23	16.1 Regular maintenance	67
6.4.1 Manufacturer instructions - electromagnetic emissions		16.2 Spare Parts	67
.....	23	16.3 Safety Technical Checks	67
6.4.2 Manufacturer instructions - electromagnetic susceptibility		17 Disposal (OptiCare)	68
.....	24	17.1 Environment Protection	68
7 Use and Storage Conditions (OptiCare)	25	17.2 Disposal	68
7.1 Storage	25	17.2.1 Within Europe	68
8 Scope of Delivery and Product Variants (OptiCare) .	25	17.2.2 Outside Europe	68
8.1 Delivery	25	18 Warranty (OptiCare)	69
8.2 Scope of Delivery	25	19 Standards and Regulations (OptiCare)	69
only OptiCare for Eleganza 5	26	19.1 OptiCare	69
9 Putting into Service (only OptiCare for Eleganza 5) .	27	19.2 Manufacturer	69
9.1 Mattress Installation	28		
9.2 SCU (System Control Unit)	29		
9.3 Replacing the mattress	29		
10 Manipulation (OptiCare for Eleganza 5)	30		
10.1 Manual CPR (during Transport or Power loss)	33		
10.2 Mattress Screen (Eleganza 5 with OptiCare).....	34		
10.3 OptiCare Mattress Controls (Eleganza 5 with OptiCare)			
.....	35		
10.3.1 MATTRESS NOT INSTALLED	35		
10.3.2 MATTRESS IDENTIFICATION	35		
10.3.3 MATTRESS INFLATION	35		
10.3.4 MATTRESS PREPARED FOR PATIENT	36		
10.3.5 PATIENT ON THE MATTRESS (OPT MODE)	36		
10.3.6 MAXIMUM MATTRESS INTERNAL PRESSURE ..	36		
10.3.7 PRESSURE COMFORT ADJUSTMENT	37		
10.3.8 MICRO-CLIMATE MANAGEMENT (MCM MODE) 37			
10.3.9 CPR MODE (CPR ACTIVATED)	37		
10.3.10 ALERTS	38		
only OptiCare for Multicare	40		

1 Symbols and Definitions

1.1 Warning Notices

1.1.1 Types of Warning Notices

Warning notices are differentiated by the type of danger using the following key words:

- ▶ **CAUTION** warns about the risk of material damage.
- ▶ **WARNING** warns about the risk of physical injury.
- ▶ **DANGER** warns about the risk of fatal injury.

1.1.2 Structure of Warning Notices



SIGNAL WORDS!

Type and source of danger!

- ▶ Measures to avoid the danger.

1.2 Instructions

Structure of instructions:

- ▶ Perform this step.
- Results, if necessary.

1.3 Lists

Structure of bulleted lists:

- List level 1
 - List level 2
 - List level 3

1.4 Patents and Trade Marks

The following Trademarks are registered Trade-marks in U.S.A.:







LINET®

OPTICARE®

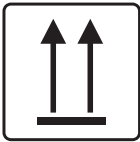

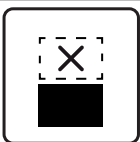





Link to the list of registered Trademarks and Patents:



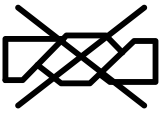





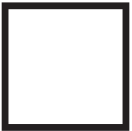

<https://www.linnet.com/en-US/about/intellectual-property>











1.5 Symbols on the Package (OptiCare)

	<p>FRAGILE, HANDLE WITH CARE</p>
	<p>THIS WAY UP</p>
	<p>KEEP DRY (PROTECT FROM HUMIDITY)</p>
	<p>PAPER RECYCLING SYMBOL</p>
	<p>DO NOT STACK DURING STORAGE</p>
	<p>DO NOT USE HAND TRUCK HERE</p>
	<p>OVERSEAS PACKAGE: STACKING LIMIT BY NUMBER (3 PACKAGES FOR TRANSPORT)</p>
	<p>OVERSEAS PACKAGE: STACKING LIMIT BY NUMBER (5 PACKAGES FOR STORAGE)</p>
	<p>RECYCLING SYMBOL</p>

1.6 Symbols and Labels on the Mattress (OptiCare)

	<p>DO NOT IRON!</p>
	<p>DO NOT USE PHENOL!</p>
	<p>DO NOT WRING!</p>
	<p>REGULARLY INSPECT THE INSIDE OF THE COVER FOR CONTAMINATION</p>
	<p>MACHINE WASH AT MAX. 71°C FOR 3 MINUTES</p>
	<p>TUMBLE DRY ON LOW HEAT SETTING (MAX. 60°C)</p>
	<p>HANDWASH WITH DETERGENT (INITIAL TEMPERATURE OF HOT WATER SHOULD NOT EXCEED 50°C)</p>
	<p>DISINFECT USING SOLUTION CONTAINING LESS THAN 1000 ppm OF CHLORINE (REFER TO INSTRUCTIONS FOR USE)</p>
	<p>WIPE WITH WATER</p>
	<p>DRY</p>

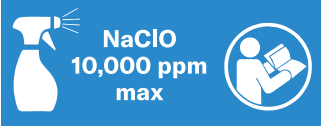
 <p>BS 7175 RESISTANT</p>	<p>COVER MATERIALS ARE FIRE RESISTANT TO BS7175, SOURCE 0, 1 AND 5</p>
	<p>MATTRESS FOOT PART (OptiCare)</p>
	<p>WEEE SYMBOL (RECYCLE AS ELECTRONIC WASTE, DO NOT PUT INTO THE HOUSEHOLD WASTE)</p>
	<p>MEDICAL DEVICE (compatible with Medical Device Regulation)</p>
	<p>MANUFACTURER</p>
	<p>MANUFACTURING DATE</p>
	<p>REFERENCE NUMBER (PRODUCT TYPE DEPENDING ON CONFIGURATION)</p>
	<p>SERIAL NUMBER</p>
	<p>ONLY SUITABLE FOR INDOOR USE</p>
	<p>APPLIED PARTS TYPE B</p>

	<p>WARNING</p>
	<p>READ INSTRUCTIONS FOR USE</p>
<div data-bbox="199 533 395 658" style="border: 1px solid black; padding: 5px; text-align: center;"> <p>FUSE RATING</p>  <p>(T)1A</p> </div>	<p>T1AH ANTI-SURGE FUSE</p>
	<p>ALTERNATING CURRENT</p>
	<p>THERMAL PROTECTION FOR TRANSFORMER</p>
	<p>SAFETY ISOLATING TRANSFORMER (GENERAL)</p>
	<p>DO NOT USE PHENOL! (DREAM AIR MIOB-44CVR)</p>
	<p>HANDWASH WITH DETERGENT (INITIAL TEMPERATURE OF HOT WATER SHOULD NOT EXCEED 50°C) (DREAM AIR MIOB-44CVR)</p>
	<p>DISINFECT USING SOLUTION CONTAINING LESS THAN 10000 ppm OF CHLORINE (REFER TO INSTRUCTIONS FOR USE) (DREAM AIR MIOB-44CVR)</p>
	<p>WIPE WITH WATER (DREAM AIR MIOB-44CVR)</p>

1.9 Abbreviations

AC (~)	Alternating Current
CE	European Conformity
CPR	Cardiopulmonary Resuscitation
dB	Sound Intensity Unit
DC (---)	Direct Current
CUC	Configuration number
EMC	Electromagnetic Compatibility
FET	Field-effect transistor
HF	High Frequency
HPL	High Pressure Laminate
ICU	Intensive Care Unit
INT.	Duty Cycle
IP	Ingress Protection
IV	Intravenous
LED	Light Emitting Diodes
ME	Medical Electrical (Equipment)
ON	Activation
OFF	Deactivation
ppm	parts per million, millionth (1000 ppm = 0,1%)
REF	Reference Number (product type depending on configuration)
SCU	System Control Unit (integrated mattress)
SN	Serial Number
SW	Software
SWL	Safe Working Load
UDI	Unique Device Identification (for medical devices)
USB	Universal Serial Bus
WEEE	Waste Electrical and Electronic Equipment

1.10 Definitions

Maximum Patient Weight	The highest allowable load on the mattress.
Adult	Patient having a physical size equal to or more than 146 cm, a mass equal to or more than 40 kg and a body mass index (BMI) equal to or more than 17 (according to IEC 60601-2-52).

2 Safety Instructions (only OptiCare for Eleganza 5)



WARNING!

Eleganza 5 bed with OptiCare integrated mattress replacement system should be left in its lowest position when the patient is unattended in order to reduce risk of injury due to falls!



WARNING!

Siderails of the Eleganza 5 bed should be located in the „up“ position to reduce the risk of the patient accidentally slipping or rolling off the OptiCare integrated mattress!



WARNING!

Inappropriate handling of the Eleganza 5 power supply cord, e. g. by kinking, shearing or other mechanical damages is hazardous!



WARNING!

When routing cables from OptiCare integrated mattress replacement system in the Eleganza 5 bed avoid squeezing those cables between parts of the Eleganza 5 bed!



WARNING!

The OptiCare integrated mattress replacement system with Eleganza 5 bed are intended for adults.
▶ Follow the chapter Intended use.



WARNING!

OptiCare integrated mattress replacement system is compatible only with Eleganza 5 bed or with Multicare bed. The OptiCare integrated mattress replacement system can only be used when installed on a LINET Eleganza 5 bed frame or on a LINET Multicare bed frame.



WARNING!

To avoid the risk of electric shock, the Eleganza 5 bed must only be connected to a supply mains with protective earth.



WARNING!

No modification of OptiCare integrated mattress replacement system is allowed.



WARNING!

Do not modify OptiCare integrated mattress replacement system without authorization of the manufacturer.



WARNING!

If OptiCare integrated mattress replacement system is modified, appropriate inspection and testing must be conducted to ensure continued safe use of the equipment.



WARNING!

An additional multiple socket-outlet or extension cord shall not be connected to the medical electrical system of the OptiCare integrated mattress replacement system with Eleganza 5 bed.



WARNING!

OptiCare integrated mattress replacement system must be used exclusively by or under supervision of trained and qualified nursing personnel!



WARNING!

Staff expert assessment is needed to consider all individual cases of contraindications!
▶ Certain bed positions are not suitable for specific diagnosis/medical conditions. Fowler position is not suitable for spinal cord injuries! Trendelenburg position is not suitable for patients with higher intracranial pressure!



WARNING!
 Length adjustment of the Eleganza 5 bed must be proportional to the height of patient and to the placement of the OptiCare integrated mattress replacement system!
 ► Risk of trapping or squeezing because of patient's body constitution disproportionate to the size of mattress support platform!



WARNING!
 During specific investigations or treatments the significant risks of reciprocal interference posed by OptiCare integrated mattress replacement system with Eleganza 5 bed may occur.



WARNING!
 Any serious incident that has occurred in relation to the device (OptiCare integrated mattress replacement system) should be reported to the manufacturer and the competent authority of the Member State in which the user and/or patient is established!



WARNING!
 Only authorised and trained person using the tool is allowed to change fuses and power supplies of the OptiCare integrated mattress replacement system!



WARNING!
 This medical device (OptiCare integrated mattress replacement system) is not intended for oxygen enriched environment!



WARNING!
 This medical device (OptiCare integrated mattress replacement system) is not intended for use with flammable substances!



WARNING!
 This medical device (OptiCare integrated mattress replacement system) is not portable medical electrical equipment!



WARNING!
 Patient is allowed to use selected control elements only if hospital personnel had assessed that the patient's physical and psychological state is in accordance with use of them and only if the hospital personnel had trained the patient in accordance with the instructions for use!



WARNING!
 Before placing the patient to prone position detailed clinical risk assessment and enhanced care in area of pressure ulcer prevention is highly recommended!

- ▶ Follow the instructions for use carefully.
- ▶ Ensure any user has read and understood the instructions for use completely before operating the product.
- ▶ Use OptiCare integrated mattress replacement system exclusively as specified in the instructions for use and in perfect working order.
- ▶ If necessary, check the OptiCare functions daily or at each shift change.
- ▶ Use the Eleganza 5 bed exclusively with the correct mains supply.
- ▶ Ensure that the OptiCare integrated mattress replacement system is operated exclusively by qualified personnel who have been trained according to the instructions for use.
- ▶ Ensure OptiCare integrated mattress replacement system is operated by qualified personnel trained in using the Eleganza 5 bed in accordance with the instructions for use by manufacturer or by person approved by the manufacturer, eventually by authorized representative or by person approved by the authorized representative.
- ▶ Ensure that the patient (health permitting) has been informed about the operation of the OptiCare integrated mattress replacement system and all applicable safety instructions.
- ▶ Contact service department of the manufacturer immediately to let it replace any damaged parts by the original spare parts.
- ▶ Ensure that maintenance and installation are performed exclusively by qualified personnel who have been trained by the manufacturer.
- ▶ During peak loads or unavoidable excess loads (CPR), adjust Mattress support platform with OptiCare integrated mattress replacement system to the lowest position.
- ▶ Ensure that only one adult patient lies on the OptiCare mattress at any time.
- ▶ To avoid injury or crushing, take extra caution when operating any moving parts of the Eleganza 5 bed.
- ▶ When using lifting poles or infusion stands, ensure that OptiCare integrated mattress replacement system will not be damaged when you move or adjust Eleganza 5 bed.
- ▶ Keep the Mattress support platform with OptiCare integrated mattress replacement system in the lowest position at any time when the healthcare personnel are not treating the patient in order to prevent the patient from falling or injuries.
- ▶ Ensure that siderails of Eleganza 5 bed are operated exclusively by healthcare personnel.
- ▶ Never handle the mains plug of Eleganza 5 bed with wet hands.
- ▶ Disconnect Eleganza 5 bed from the mains exclusively by pulling the mains plug.
- ▶ When pulling the mains plug, always hold the plug, not the cable.
- ▶ Improper handling of mains cable can cause an electric shock hazard, other serious injuries or damage to OptiCare mattress replacement system.
- ▶ Ensure that the stipulated duty cycle of Eleganza 5 bed is not exceeded.
- ▶ To prevent failures, use exclusively the manufacturer's original accessories.
- ▶ Ensure that the stipulated safe working load is not exceeded.
- ▶ If the patient's condition could lead to an entrapment, leave the mattress support platform with OptiCare integrated mattress replacement system in the flat position whilst unattended.
- ▶ Do not exceed the maximum patient weight limit of the Eleganza 5 and of the OptiCare integrated mattress replacement system at the same time.
- ▶ Do not use the SCU near flammable gases. (This does not apply to oxygen cylinders.)
- ▶ Do not hang anything on any cable.
- ▶ Never use OptiCare integrated mattress replacement system near radiators or other heat sources.
- ▶ After each emergency situation always check if any of the Eleganza 5 controllers (controllers in siderails, handset or Attendant Control Panel) is not involuntarily pressed by the bed accessories or by the OptiCare integrated mattress.
- ▶ To avoid unintended activation of moving parts during any use of the bed always check that none of the control elements of the Eleganza 5 bed is pressed by persons, by OptiCare integrated mattress or by other objects.
- ▶ Never cover the SCU while in use.
- ▶ Never cover the filter of SCU while in use.

3 Safety Instructions (only OptiCare for Multicare)



WARNING!
Multicare bed with OptiCare integrated mattress replacement system should be left in its lowest position when the patient is unattended in order to reduce risk of injury due to falls!



WARNING!
Siderails of the Multicare bed should be located in the „up“ position to reduce the risk of the patient accidentally slipping or rolling off the OptiCare integrated mattress!



WARNING!
Inappropriate handling of the Multicare power supply cord, e. g. by kinking, shearing or other mechanical damages is hazardous!



WARNING!
When routing cables from OptiCare integrated mattress replacement system in the Multicare bed avoid squeezing those cables between parts of the Multicare bed!



WARNING!
The OptiCare integrated mattress replacement system with Multicare bed are intended for adults.
▶ Follow the chapter Intended use.



WARNING!
OptiCare integrated mattress replacement system is compatible only with Multicare bed or with Eleganza 5 bed. The OptiCare integrated mattress replacement system can only be used when installed on a LINET Multicare bed frame or on a LINET Eleganza 5 bed frame.



WARNING!
To avoid the risk of electric shock, the Multicare bed must only be connected to a supply mains with protective earth.



WARNING!
No modification of OptiCare integrated mattress replacement system is allowed.



WARNING!
Do not modify OptiCare integrated mattress replacement system without authorization of the manufacturer.



WARNING!
If OptiCare integrated mattress replacement system is modified, appropriate inspection and testing must be conducted to ensure continued safe use of the equipment.



WARNING!
An additional multiple socket-outlet or extension cord shall not be connected to the medical electrical system of the OptiCare integrated mattress replacement system with Multicare bed.



WARNING!
OptiCare integrated mattress replacement system must be used exclusively by or under supervision of trained and qualified nursing personnel!



WARNING!
Staff expert assessment is needed to consider all individual cases of contraindications!
▶ Certain bed positions are not suitable for specific diagnosis/medical conditions. Fowler position is not suitable for spinal cord injuries! Trendelenburg position is not suitable for patients with higher intracranial pressure!



WARNING!

Length adjustment of the Multicare bed must be proportional to the height of patient and to the placement of the OptiCare integrated mattress replacement system!

- ▶ Risk of trapping or squeezing because of patient's body constitution disproportionate to the size of mattress support platform!



WARNING!

During specific investigations or treatments the significant risks of reciprocal interference posed by OptiCare integrated mattress replacement system with Multicare bed may occur.



WARNING!

Any serious incident that has occurred in relation to the device (OptiCare integrated mattress replacement system) should be reported to the manufacturer and the competent authority of the Member State in which the user and/or patient is established!



WARNING!

Only authorised and trained person using the tool is allowed to change fuses and power supplies of the OptiCare integrated mattress replacement system!



WARNING!

This medical device (OptiCare integrated mattress replacement system) is not intended for oxygen enriched environment!



WARNING!

This medical device (OptiCare integrated mattress replacement system) is not intended for use with flammable substances!



WARNING!

This medical device (OptiCare integrated mattress replacement system) is not portable medical electrical equipment!



WARNING!

Patient is allowed to use selected control elements only if hospital personnel had assessed that the patient's physical and psychological state is in accordance with use of them and only if the hospital personnel had trained the patient in accordance with the instructions for use!



WARNING!

Before placing the patient to prone position detailed clinical risk assessment and enhanced care in area of pressure ulcer prevention is highly recommended!

- ▶ Follow the instructions for use carefully.
- ▶ Ensure any user has read and understood the instructions for use completely before operating the product.
- ▶ Use OptiCare integrated mattress replacement system exclusively as specified in the instructions for use and in perfect working order.
- ▶ If necessary, check the OptiCare functions daily or at each shift change.
- ▶ Use the Multicare bed exclusively with the correct mains supply.
- ▶ Ensure that the OptiCare integrated mattress replacement system is operated exclusively by qualified personnel who have been trained according to the instructions for use.
- ▶ Ensure OptiCare integrated mattress replacement system is operated by qualified personnel trained in using the Eleganza 5 bed in accordance with the instructions for use by manufacturer or by person approved by the manufacturer, eventually by authorized representative or by person approved by the authorized representative.
- ▶ Ensure that the patient (health permitting) has been informed about the operation of the OptiCare integrated mattress replacement system and all applicable safety instructions.
- ▶ Contact service department of the manufacturer immediately to let it replace any damaged parts by the original spare parts.
- ▶ Ensure that maintenance and installation are performed exclusively by qualified personnel who have been trained by the manufacturer.
- ▶ During peak loads or unavoidable excess loads (CPR), adjust Mattress support platform with OptiCare integrated mattress replacement system to the lowest position.
- ▶ Ensure that only one adult patient lies on the OptiCare mattress at any time.
- ▶ To avoid injury or crushing, take extra caution when operating any moving parts of the Multicare bed.
- ▶ When using lifting poles or infusion stands, ensure that OptiCare integrated mattress replacement system will not be damaged when you move or adjust Multicare bed.
- ▶ Keep the Mattress support platform with OptiCare integrated mattress replacement system in the lowest position at any time when the healthcare personnel are not treating the patient in order to prevent the patient from falling or injuries.
- ▶ Ensure that siderails of Multicare bed are operated exclusively by healthcare personnel.
- ▶ Never handle the mains plug of Multicare bed with wet hands.
- ▶ Disconnect Multicare bed from the mains exclusively by pulling the mains plug.
- ▶ When pulling the mains plug, always hold the plug, not the cable.
- ▶ Improper handling of mains cable can cause an electric shock hazard, other serious injuries or damage to OptiCare mattress replacement system.
- ▶ Ensure that the stipulated duty cycle of Multicare bed is not exceeded.
- ▶ To prevent failures, use exclusively the manufacturer's original accessories.
- ▶ Ensure that the stipulated safe working load is not exceeded.
- ▶ If the patient's condition could lead to an entrapment, leave the mattress support platform with OptiCare integrated mattress replacement system in the flat position whilst unattended.
- ▶ Do not exceed the maximum patient weight limit of the Multicare and of the OptiCare integrated mattress replacement system at the same time.
- ▶ Do not use the SCU near flammable gases. (This does not apply to oxygen cylinders.)
- ▶ Do not hang anything on any cable.
- ▶ Never use OptiCare integrated mattress replacement system near radiators or other heat sources.
- ▶ After each emergency situation always check if any of the Multicare controllers (controllers in siderails, handset or Attendant Control Panel) is not involuntarily pressed by the bed accessories or by the OptiCare integrated mattress.
- ▶ To avoid unintended activation of moving parts during any use of the bed always check that none of the control elements of the Multicare bed is pressed by persons, by OptiCare integrated mattress or by other objects.
- ▶ Never cover the SCU while in use.
- ▶ Never cover the filter of SCU while in use.

4 Intended use of OptiCare

The intended purpose of this mattress is to provide a support surface for patients by pressure redistribution designed for management of tissue loads and microclimate management. This mattress is intended to be used with integrated air compressor of Multicare LINET medical bed and Eleganza 5 LINET medical bed.

4.1 Indications

The mattress is recommended for use with patients who have been identified as having from low to very high-risk rating of pressure injuries development, (very high risk includes patients with pressure injuries in the past or currently having a pressure injury of any category) according to EPUAP/NPIAP standards for pressure injury prevention in line with local policy and guidelines.

The use of the mattress does not remove the need for regular repositioning of patients in line with best clinical practice.

NOTE: A full risk assessment of the patient's risk of a pressure injury development must be carried out by an appropriately trained clinician and clinical judgement must be made to identify the suitability of the product for use with the patient.

4.2 User population of OptiCare

- ▶ Adult patients (weight \geq 40 kg, height \geq 146 cm, BMI \geq 17)
- ▶ Application Environment 1 (ICU) and 2 (Acute care), as in IEC 60601-2-52

4.3 Contraindications

Mattress system is contraindicated for patients:

1. with cervical or skeletal traction
2. with unstable skeletal fractures
3. with unstable spinal fractures
4. exceeding maximum patient weight of the mattress

Other contraindications may be identified on an individual patient basis depending on clinical risk assessment.

NOTE: For patients in prone position - before placing the patient into prone position a detailed clinical risk assessment should be carried out by an appropriately trained clinician.

4.4 Operator

- ▶ Caregivers (nurses/doctors) that are fully trained in use of the mattress. Operators must familiarize themselves with all warnings and cautions contained in the instructions for use before use of the mattress. Clinical risk assessment should be carried out by appropriately trained staff and clinical judgement should be made to ascertain that the product is suitable for meeting the care needs of the individual patient.
- ▶ Technical, transport and cleaning personnel should be fully trained in the maintenance and service of the product and must familiarize themselves with all warnings and cautions contained in the instructions for use.

5 Product Description (OptiCare)

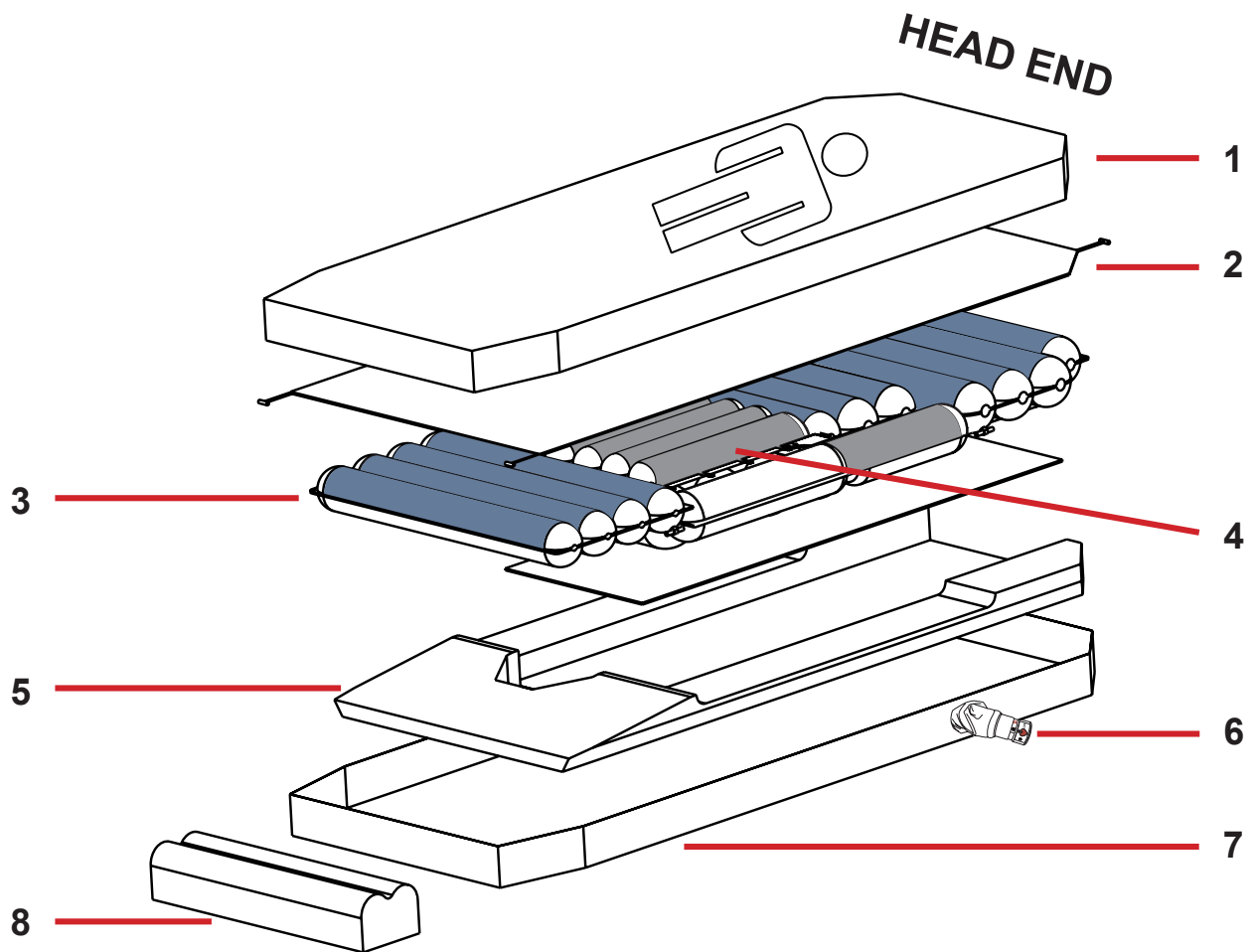

Fig. OptiCare Mattress Description

- 1. Cover
- 2. Comfort Layer
- 3. Air Cell Set (Area B - blue)
- 4. Air Cell Set (Area A - grey)
- 5. Foam Base
- 6. CPR Valve
- 7. Base Cover
- 8. Heel Section

5.1 Mattress Structure

The OptiCare mattress consists of 4 sections that are held together by 6 quick release fixation toggles. The 3 sections include cover, comfort layer, air cell set and foam base which supports the leg section and side formers. Within the central cut-out of the foam base is a 10 mm high density foam sheet to protect the patient if the mattress is deflated. Air cell set is divided into Area A and Area B. A two-part cover (1) made of water proof vapour permeable material encloses the mattress. Beneath the cover and on the top of the upper air layer is a removable polyester comfort layer (2). The 2 air layers consist of 10 separate air modules for easy and cost effective replacement in case of user damage. 7 of these air modules are connected together to form the Constant Low Pressure air mattress, while the other 3 act as air manifolds for the Micro-Climate Management (MCM) function. The mattress has a 7 degree heel slope to help further off-loading of pressure in the vulnerable heel area.

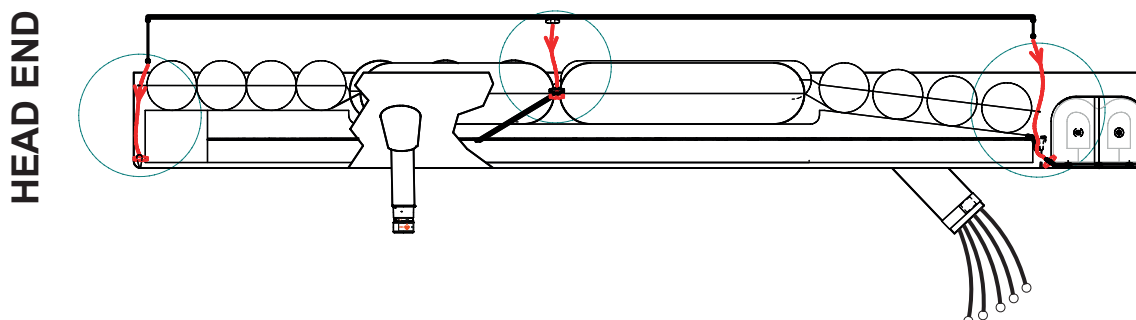

Fig. Fixation of Comfort Layer to the cells (Fixation toggles)

5.2 Cover

The top part of the cover consists of highly moisture- and vapour-permeable (MVP) two-way stretch material which forms an integral part of the Micro-Climate Management (MCM) function. The cover top is equipped with a full 360-degree zip to allow easy removal for cleaning or replacement. The zip is covered by a waterproof flap to protect the mattress against fluid ingress. The cover base is made from water-impermeable high-strength non-stretch material that is suitable for any demanding environment. Additional quick-release straps prevent the mattress from shifting if the head board or foot board is removed.

5.3 Bottom Deck

The bottom air layer is enclosed by a foam base fully contained within a removable waterproof cover. This provides support for the patient when entering or exiting the bed. The angled sides of the foam base are designed to fit securely into the shaped sides of the Eleganza 5 patient platform or Multicare patient platform to prevent any movement of the mattress when the patient is getting into or out of the bed.

5.4 Heel section

The heel section is made up of 2 foam in air cells each with a custom designed internal foam shape that allows the 2 cells to collapse back into a reduced shape when pressed in by the foot board of the bedframe. This reduces the length of the mattress by 190 mm when compressed. The heel cells will self inflate when the bed is lengthened.

5.5 Safety Straps

The sides of the foam base fit the sides of the Eleganza 5 mattress support platform or Multicare mattress support platform to prevent the mattress from shifting when the patient is getting into or out of bed. The mattress is equipped with additional quick-release straps to prevent the mattress from shifting if the head or foot board is removed. These straps are located on head end and foot end of the bed.

To fix the strap:

- ▶ Loop black strap around metal bed frame and feed it back through the plastic clip.

To release the strap:

- ▶ Pull loose end of strap upward to release clip.

5.6 Transport Handles



WARNING!

Material damage and risk of injury due to incorrect use!

- ▶ Transport the mattress using transport handles without patient on it!

Transport handles are intended for transport of the mattress.

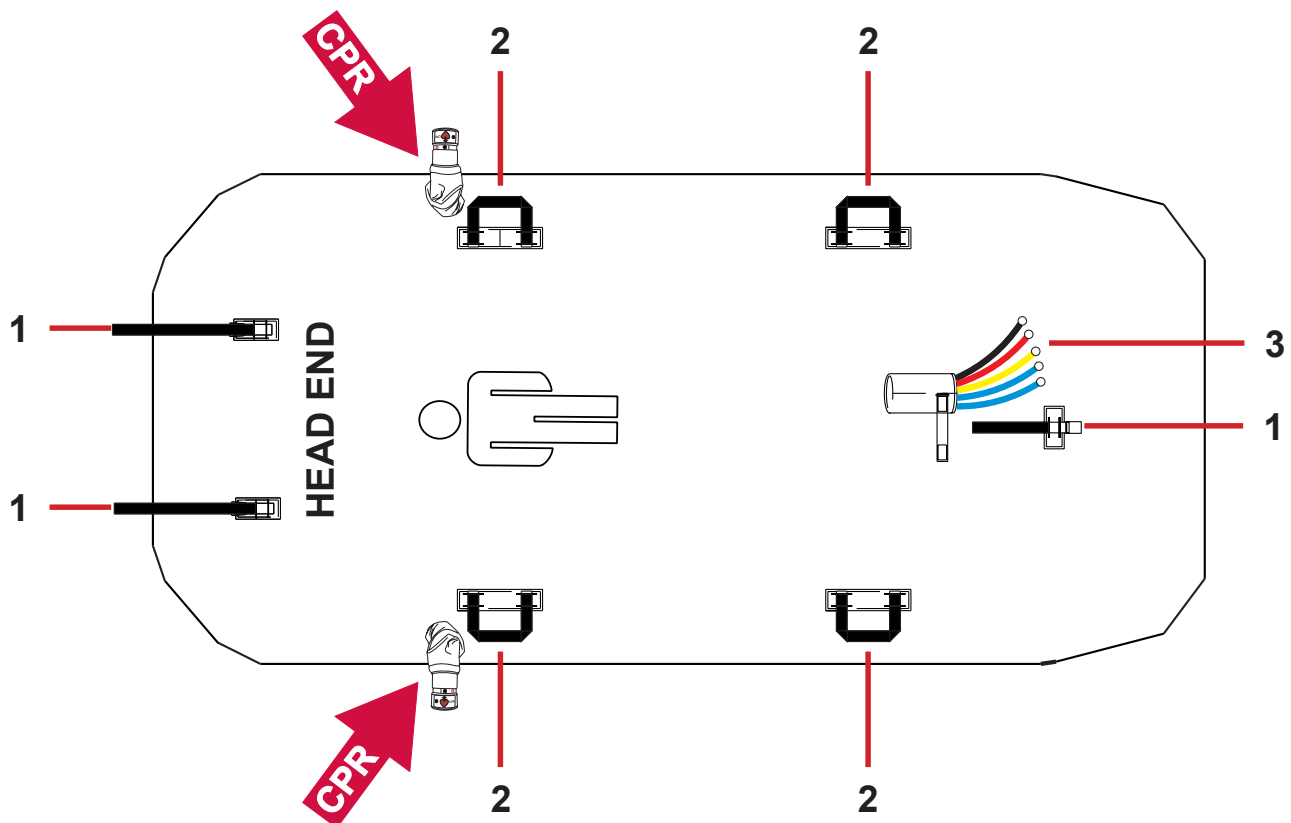

Fig. Base Cover Description

- 1. Safety Straps
(to fix mattress on the Mattress Platform)
- 2. Transport Handles
- 3. Aip Pipes

5.7 SCU (System Control Unit)

The SCU (System Control Unit) is installed under the leg section of the bed frame. It is possible to have the Eleganza 5 bed or Multicare bed delivered with the SCU factory-fitted, or to have it retrofitted by approved service personnel. OptiCare ready Eleganza 5 bed or OptiCare ready Multicare bed are equipped with a dedicated power outlet for the SCU at the auxiliary power distribution point. The SCU is operated via the Mattress Section on the iBoard Standard. There is no ON/OFF switch on SCU. The SCU is equipped with a comprehensive alarm system which detects any problems with the system performance.

The alarm system

- ▶ gives audible and visual alarms via the iBoard Standard if a problem requires immediate action.
- ▶ stores information for the service personnel to review later.

5.7.1 FIRMWARE

The system control unit includes firmware that can be updated only by an authorised service technician. This firmware is protected against unauthorised access by mechanical housing (tool is needed to access) and by exclusive compatibility with an authorised software tool and specific cable.

6 Technical Specification (OptiCare)

All technical data are rated data and are subject to construction and manufacturing tolerances.



WARNING!

If Eleganza 5 bed or Multicare bed are used with OptiCare integrated mattress replacement system, respect values of mechanical and electrical specifications which can harm none of them!

6.1 Mechanical Specifications

Parameter	Value
External dimensions of Inflated Mattress	214 cm (84,3 inch) x 86 cm (33,9 inch) x 22 cm (8,7 inch)
External dimensions of SCU	33 cm (13 inch) x 23,5 cm (9,3 inch) x 12 cm (4,7 inch)
Weight of Inflated Mattress	13 kg (29 lbs)
Weight of SCU	6 kg (13 lbs)
Inflation time after storage	max. 15 min (typical < 10 min)
CPR deflation time (depending on patient weight, chosen mode - optimization or maximum internal pressure - and on type of CPR - electric or manual)	max. 30 s
Remain Inflated in Transport Mode	12 hours (whem starting from Maximum Inflate Mode)
Maximum Mattress Load (SWL)	250 kg (551 lbs)
Minimum Mattress Load	40 kg
Cover Fire Resistance	according to BS7175 - ignition source 5
Whole Mattress Fire Resistance	according to BS7177 - ignition source 5
Top Cover Biocompatibility	ISO 10993-5 (cytotoxicity), ISO 10993-10 (skin sensation and irritation)

6.2 Environment conditions

Use Conditions	
Ambient Temperature	10°C - 40°C
Relative Humidity	30% - 75 %
Atmospheric Pressure	795 - 1060 hPa
Storage and Transport Conditions	
Ambient Temperature	-40°C - 70°C
Relative Humidity	10% - 100 % (non-condensing)
Atmospheric Pressure	795 - 1060 hPa

6.3 Electrical Specifications

Parameter	Value
Input Voltage, Frequency: USA version Brazilian version EU version	100-127 V AC, 50/60 Hz 220 V AC, 60 Hz 220-240 V AC, 50/60 Hz
Maximum Power Input	max. 40 VA (when operating from mains supply)
Ingress Protection (EN 60529)	IPX4
Protection Class	Class I with Applied Parts Type B
Electrical Safety	in conformity with EN 60601-1
Fuse Version 220-240 V Version 100-127 V	2 x T0,5AH Anti-surge Fuse 2 x T1AH Anti-surge Fuse

6.4 Electromagnetic Compatibility

OptiCare integrated mattress replacement system is intended for hospitals except for near active HF surgical equipment and the RF shielded room of a medical system for magnetic resonance imaging, where the intensity of EM disturbances is high.

OptiCare integrated mattress replacement system has defined no essential performance.



WARNING!

It is recommended to avoid the use of this device next to or in block with other device, because it could lead to improper operation. If such use is needed, this device and the other equipment should be under surveillance to verify proper operation. (Does not apply for compatible medical bed from LINET)

List of used cables:

- ▶ **Mains cable**, maximum length 6 m



WARNING!

Use of the accessories, converters and other cables, than specified and provided by manufacturer of this OptiCare integrated mattress replacement system could lead to increase of electromagnetic emission or lower the electromagnetic immunity of this OptiCare integrated mattress replacement system and lead to improper operation.



WARNING!

Mobile RF communication device (including end use devices like antenna cables and external antenna) should not be used closer than 30 cm (12 inches) from any part of this OptiCare integrated mattress replacement system, including cables specified by manufacturer. Otherwise this could lead to deterioration of functionality of this OptiCare integrated mattress replacement system.



WARNING!

Do not overload the OptiCare integrated mattress replacement system (SWL), respect the duty cycle (INT.) and consider chapter 12 Maintenance in order to maintain the basic safety with regard to electromagnetic disturbances for the expected service life.

6.4.1 Manufacturer instructions - electromagnetic emissions

Emission Test	Compliance
RF emissions CISPR 11	Group 1
RF emissions CISPR 11	Class B
Harmonic emissions IEC 61000-3-2	Class A
Voltage fluctuations / flicker emissions IEC 61000-3-3	Complies

6.4.2 Manufacturer instructions - electromagnetic susceptibility

Immunity Tests	Compliance level
Electrostatic discharge (ESD) IEC 61000-4-2	± 8 kV for contact discharge ± 15 kV for contact discharge
Radiated RF IEC 61000-4-3	3 V/m 80 MHz – 2,7 GHz 80 % AM at 1 kHz
Proximity fields from RF wireless communications equipment IEC 61000-4-3	See Table 1
Fast electrical transients / burst IEC 61000-4-4	±2 kV for power line repetition frequency 100 kHz
Surge IEC 61000-4-5	± 1 kV Line-to-line ± 2 kV Line-to-ground
Conducted RF IEC 61000-4-6	3 V (0,15 MHz – 80 MHz) 6 V in ISM bands between 0,15 MHz and 80 MHz 80 % AM at 1 kHz
Power frequency (50/60 Hz) magnetic field IEC 61000-4-8	30 A/m
Voltage dips, short interruptions on power supply input lines IEC 61000-4-11	0 % UT; 0,5 cycle At 0°, 45°, 90°, 135°, 180°, 225°, 270° a 315° 0 % UT; 1 cycle and 70 % UT; 25/30 cycle Single phase: at 0° 0 % UT; 250/300 cycle

Table 1 - IMMUNITY to RF wireless communications equipment

Test frequency (MHz)	Band (MHz)	Service	Modulation	Immunity Test Level V/m
385	380 - 390	TETRA 400	Pulse modulation 18 Hz	27
450	430 - 470	GMRS 460, FRS 460	FM ± 5 kHz deviation 1 kHz sine	28
710 745 780	704 - 787	LTE band 13, 17	Pulse modulation 217 Hz	9
810 870 930	800 - 960	GSM 800/900, TETRA 800, iDEN 820, CDMA 850, LTE band 5	Pulse modulation 18 Hz	28
1 720 1 845 1 970	1 700 - 1 990	GSM 1800; CDMA 1900; GSM 1900; DECT; LTE band 1, 3, 4, 25; UMTS	Pulse modulation 217 Hz	28
2 450	2 400 - 2 570	Bluetooth, WLAN, 802.11 b/g/n, RFID 2450, LTE band 7	Pulse modulation 217 Hz	28
5 240 5 500 5 785	5 100 - 5 800	WLAN 802.11 a/n	Pulse modulation 217 Hz	9

NOTE There are applied no deviations to requirements of IEC 60601-1-2 ed. 4

NOTE There are no known other measures for keeping the basic safety based on EMC phenomena.

7 Use and Storage Conditions (OptiCare)



DANGER!

Danger to life due to electric shock!

To ensure the bed's class I protection against electric shocks:

- ▶ Ground the mains.
- ▶ Use exclusively Hospital Grade or Hospital Only receptacles for grounding.

Eleganza 5 with OptiCare integrated mattress replacement system and Multicare with OptiCare integrated mattress replacement system are designed for use in rooms for medical purposes. Electrical installations must therefore meet local norms laying down the necessary conditions for electrical installations.

- ▶ Disconnect the bed from the mains in exceptional cases (i.e. lightnings, earthquake).

OptiCare integrated mattress replacement system is not suitable for indoor environments containing flammable gases (except oxygen cylinders).

7.1 Storage

When SCU is not in use:

- ▶ Logg off the mattress.
- ▶ Unplug mains cable.

When mattress is not in use:

- ▶ Unclip all 5 air pipes.
- ▶ Undo webbing strap next to air pipes.
- ▶ Make sure mattress has been cleaned and is completely dry inside and out (see Cleaning/Disinfection).
- ▶ Deflate mattress and leave air connector open (CPR position).
- ▶ Roll mattress up carefully to get air out completely.
- ▶ Place mattress in storage bag.
- ▶ Store in a dry and safe place and keep away from sharp objects.

8 Scope of Delivery and Product Variants (OptiCare)

8.1 Delivery

- ▶ Upon receipt, check that the shipment is complete as specified on the delivery note.
- ▶ Notify the carrier and supplier of any deficiencies or damages immediately as well as in writing or make a note on the delivery note.

8.2 Scope of Delivery

- OptiCare integrated mattress
- Mattress Cover
 - ELITE
 - ENDURANCE
 - with X-ray Pocket
 - without X-ray Pocket
 - ZONED
 - with X-ray Pocket
 - without X-ray Pocket
- SCU (System Control Unit)
- Instructions for use

only OptiCare for Eleganza 5

9 Putting into Service (only OptiCare for Eleganza 5)



WARNING!

Risk of injury when working on the OptiCare integrated mattress replacement system!

- ▶ Ensure that the Eleganza 5 bed is disconnected from the mains connection prior to putting OptiCare integrated mattress replacement system into service, putting it out of service and maintenance.
- ▶ Ensure that the castors are locked prior to putting OptiCare integrated mattress replacement system into service, putting out of service and maintenance.



CAUTION!

Material damage due to incorrect putting into service!

- ▶ Ensure that putting into service is performed exclusively by manufacturer's customer service or trained hospital personnel.

The OptiCare mattress replacement system replaces any mattress on the Eleganza 5 bed frame.

- ▶ Remove any existing mattress.
- ▶ Put mattress on the Mattress support platform with air pipes at foot end of the bed.
- ▶ Connect Air Pipes to SCU observing colour code.
- ▶ Make sure that the CPR valves on both sides of the head end of the mattress are not left open but connected and accessible to manipulation.

NOTE During first installation of the mattress CPR valve is open!

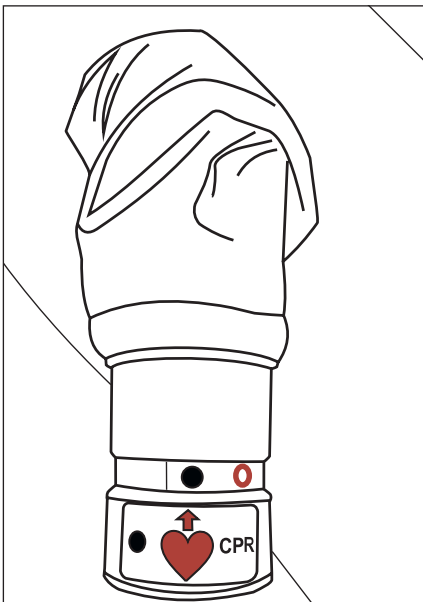

Fig. Closed CPR valve

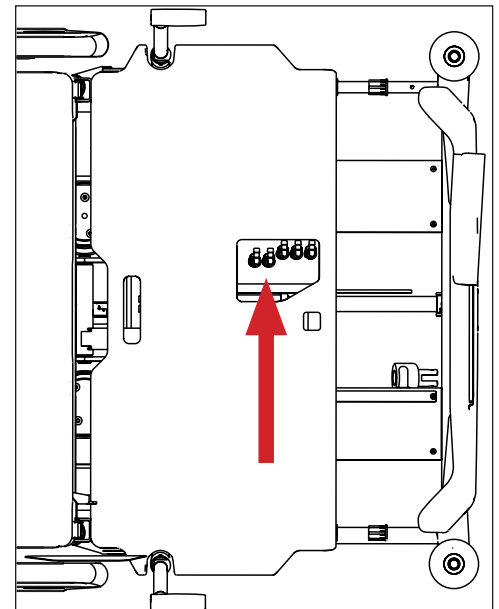

Fig. SCU with Air Pipes

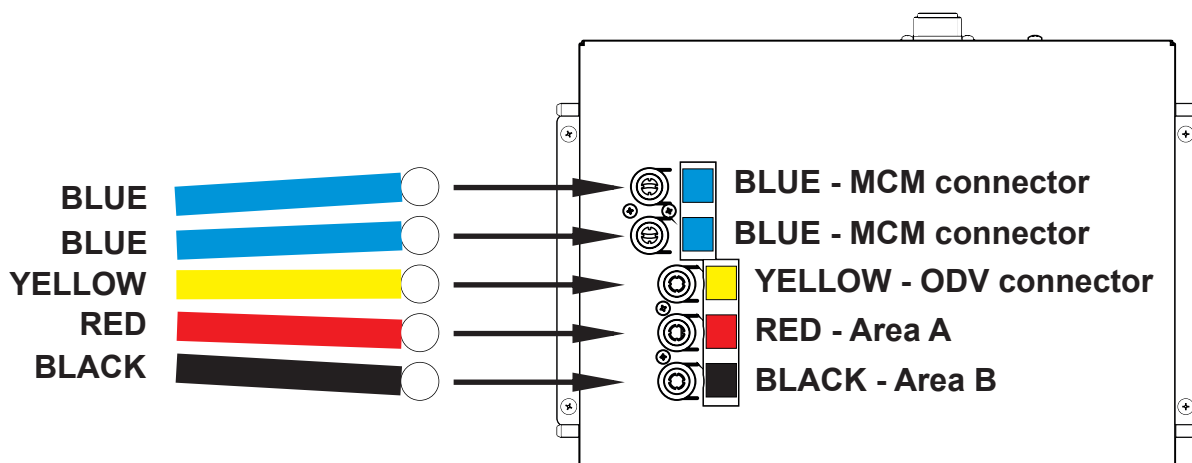

Fig. Air Pipes and SCU with Air Pipe Connectors

9.1 Mattress Installation



CAUTION!

Risk of material damage due to an incorrect fixation of OptiCare mattress on the mattress support platform!

- ▶ Adjust the bed to maximum Cardiac Chair Position before fixing all the straps of the inflated mattress to the mattress support platform!

To fix mattress on the Mattress Support Platform:

- ▶ Run three straps through the three corresponding holes in the Mattress Support Platform.
- ▶ Run these three straps under the bars of the Mattress Support Platform.
- ▶ Lock the three side release buckles by connecting their male and female parts.

To remove mattress from the Mattress Support Platform:

- ▶ Release the three buckles by pressing them from both sides and by disconnecting their male and female parts.
- ▶ Pull these three straps out of the Mattress Support Platform.
- ▶ Remove mattress from the Mattress Support Platform.

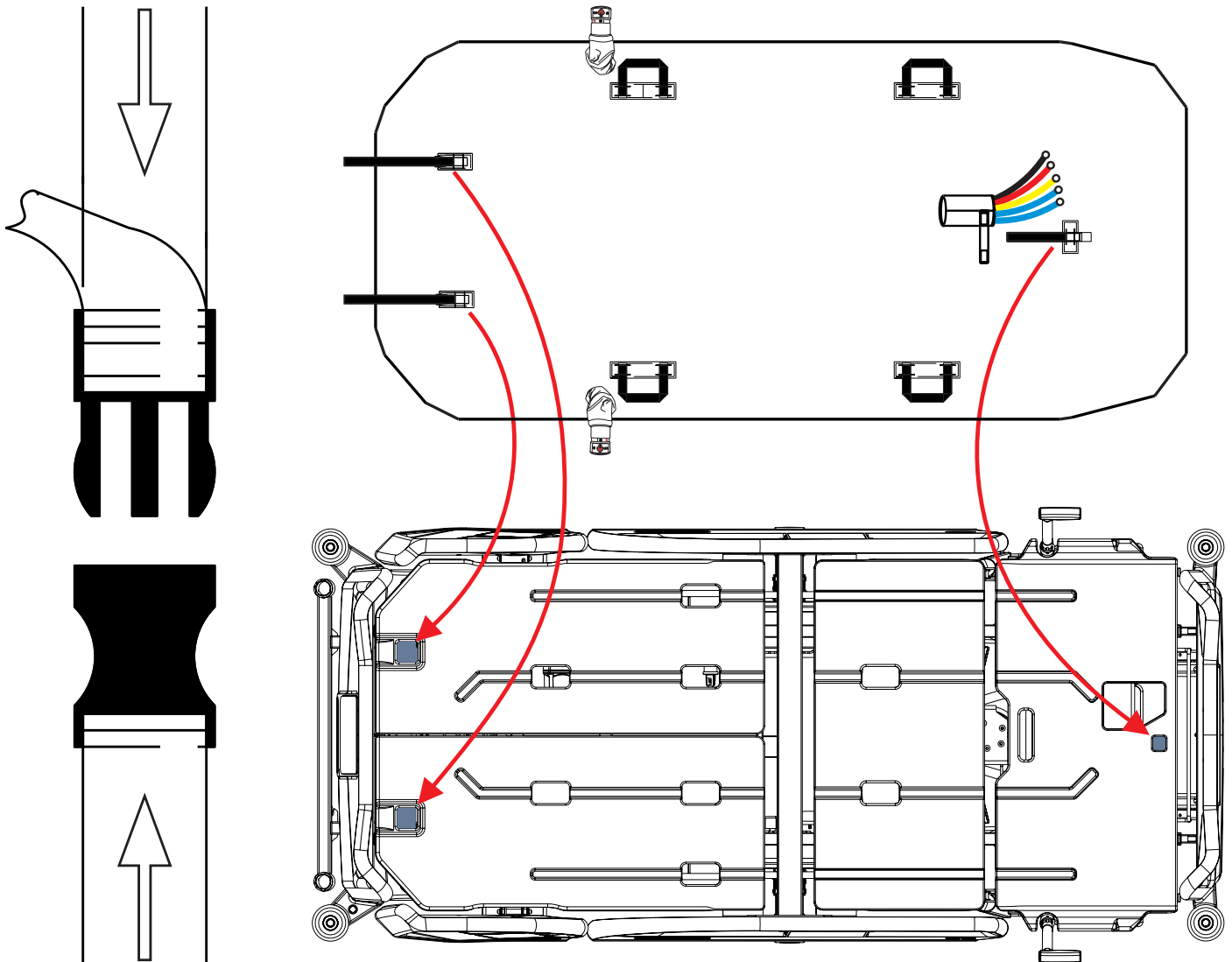

Fig. Fixation of the OptiCare mattress with straps on the mattress support platform of Eleganza 5 bed

9.2 SCU (System Control Unit)

**WARNING!**

OptiCare mattress is compatible with System Control Unit delivered by manufacturer only!

- ▶ Do not use any other System Control Unit with OptiCare mattress!

**CAUTION!**

Material damage due to incorrect installation of SCU!

- ▶ If the SCU does not come factory-fitted, have it installed by a service engineer authorised by LINET ®.

Mattress Detection System (MDS)

Sensors in the System Control Unit (SCU) Area A, B and ODV mattress air connectors detect that a valid air connector has been connected. When all three correct air connectors are detected, the SCU will enter Standby mode. In Standby mode mattress areas A and B are inflated to a static pressure ready for a patient to be placed onto the mattress and Optimization to start.

9.3 Replacing the mattress

When replacing the OptiCare mattress with an alternative active mattress from the LINET integrated systems, the system will automatically detect that type of mattress that has been connected and switch to the correct iBoard Standard control screen. If replacing the OptiCare mattress with one that is not from the LINET integrated systems range then you will need to cancel the Mattress Not Connected alarm.

Logging out the OptiCare:

When replacing the OptiCare mattress by a mattress that is not part of the LINET OptiCare integrated mattress range, it is necessary to log out OptiCare.

- ▶ Press and hold  to log out mattress. Text „**M OFF**“ is displayed.

10 Manipulation (OptiCare for Eleganza 5)

Preparing OptiCare for patient



DANGER!

Risk of suffocation due to air-impermeable mattress cover!

- ▶ Use mattress cover correctly.
- ▶ The nursing staff are responsible for the safety of the patient on the mattress cover.



WARNING!

Risk of injury when positioning patient on the bed!

Before positioning the patient on the bed:

- ▶ Ensure that mattress is completely and correctly inflated.
- ▶ Ensure that mattress is correctly secured with safety straps.



CAUTION!

Material damage due to dampness or contamination!

- ▶ Make sure mattress cover has been cleaned and is completely dry (see Cleaning/ Disinfection).

Preparation

- ▶ Inflate mattress.
- ▶ Put a sheet loosely on the mattress if not prescribed otherwise by qualified personnel.

Positioning the Patient on the Bed

- ▶ Put the patient on the mattress. Patient must be put to the centre of mattress support platform.

Create the ideal patient position:

- ▶ If additional blankets or sheets are used, make sure that ease of movement is sufficient.
- ▶ Ensure that blankets, sheets, clothing etc. do not cause pressure injuries (e.g. due to creases, seams etc.).
- ▶ Do not place any additional sheets, blankets etc. between mattress and patient.

Patient's position on the mattress



WARNING!

Risk of injury due to incorrect use!

- ▶ Regularly check patient's position on the mattress! Patient must be put to the centre of mattress support platform in horizontal position! Head of a lying patient must point towards the bed head end. Position of patient's hip joints above the bed seat section must be in accordance with arrow-like symbols on the inner sides of the Head Board and Foot Board. Ensure the patient's hip joints are located between the arrows on the siderail release levers under the foot siderails.
- ▶ Adjust bed extension according to patient's needs if a patient sitting in bed with lifted Backrest touches the bed foot board by his or her foot or feet.
- ▶ Do not move a patient back towards bed head end if the patient is sliding on the mattress during lifting of the Backrest.

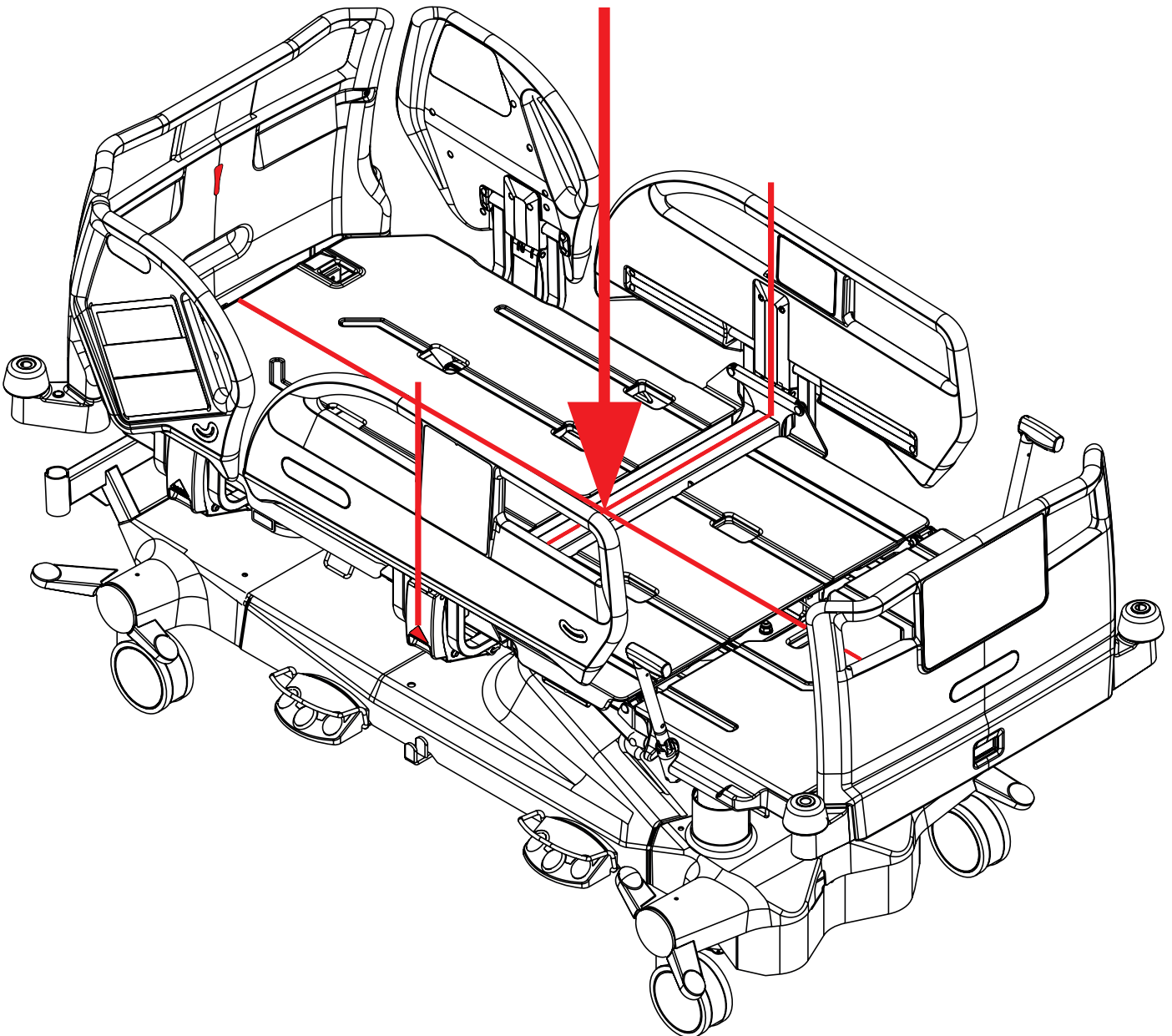

Fig. Instructions for finding the bed centre where patient must be located on the mattress

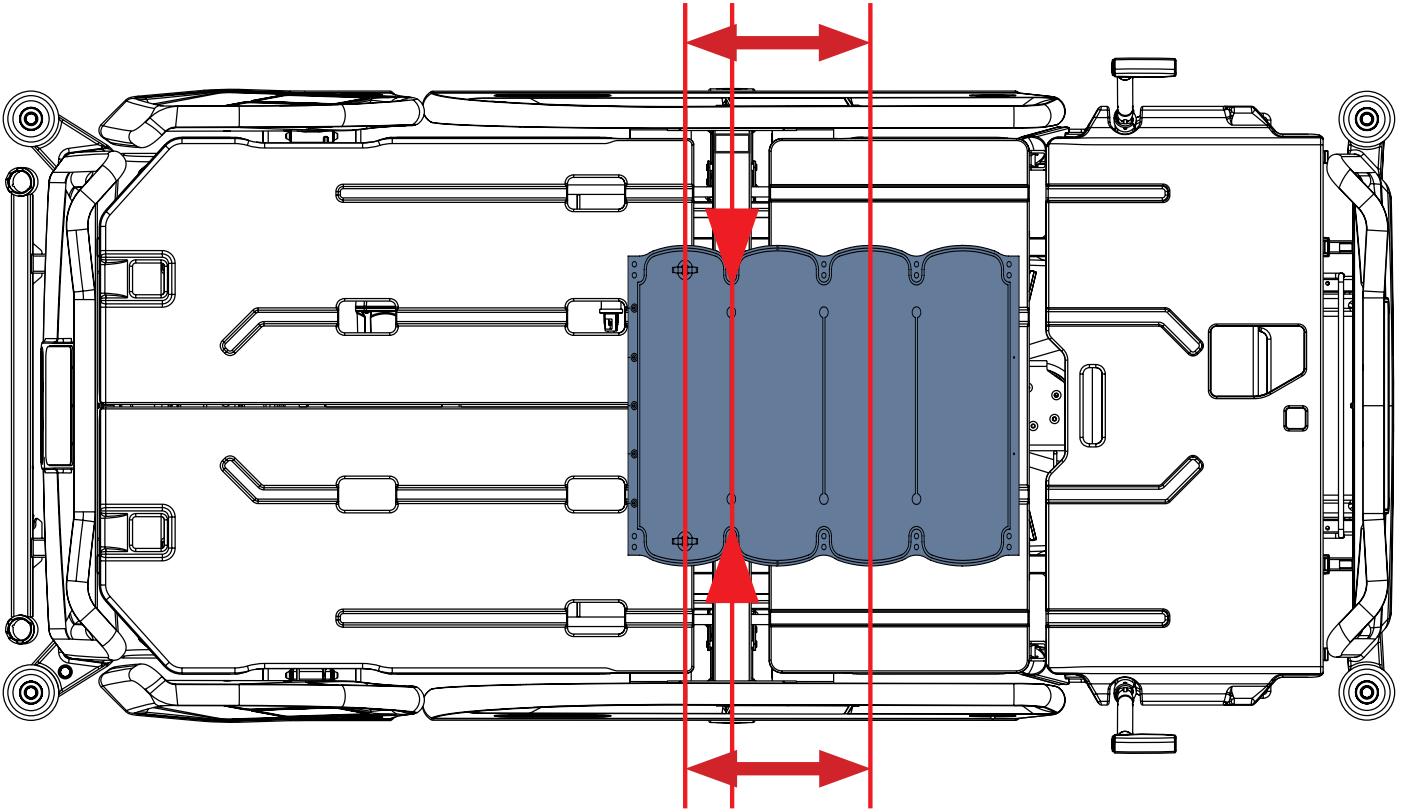

Fig. Area where patient's hip joints must be located on the mattress

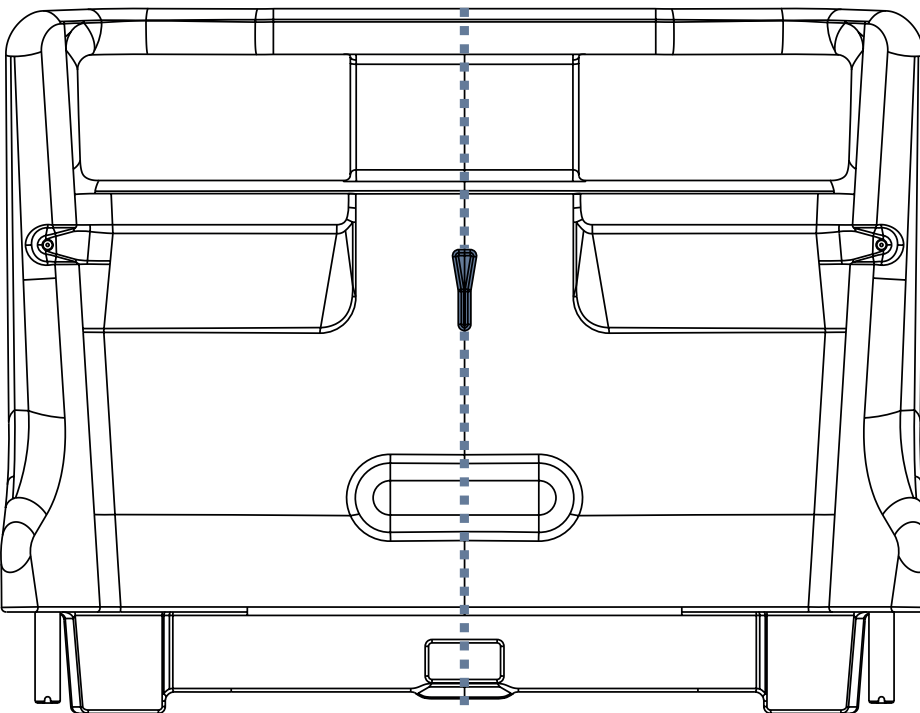

Fig. Inner side of Head Board with the arrow-like symbol indicating the centre of mattress support platform



Fig. Arrow-like symbol on the inner sides of the Head Board and Foot Board indicating the centre of mattress support platform

10.1 Manual CPR (during Transport or Power loss)

OptiCare is equipped with CPR valve on both sides next to the Manual Backrest Release.

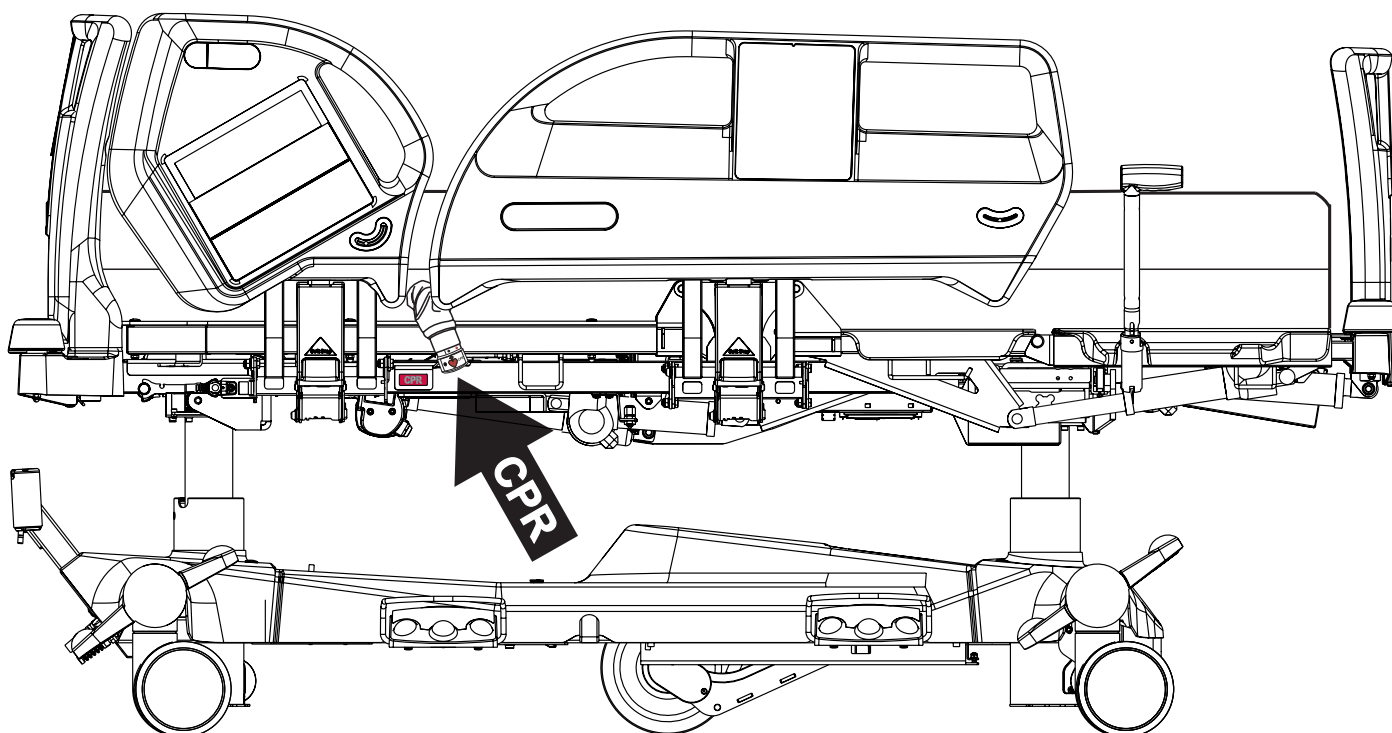

Fig. Position of the CPR valve on the OptiCare integrated mattress placed on the Eleganza 5 bed

To activate manual CPR:

- ▶ Open CPR valve on patient's left- or right-hand side by turning the end of CPR valve to the right and aligning the CPR red heart with the red circle.
- ▶ The mattress will deflate.
- ▶ The mattress support platform will flatten if bed CPR lever is used with opening of the mattress CPR valve.

NOTE The Mattress support platform will not enter the CPR position unless the CPR Button on the Positioning Section of iBoard Standard is also pressed and held until the correct position has been reached.

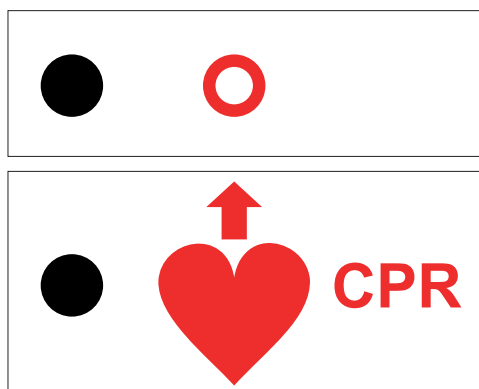

Fig. OPEN CPR VALVE

10.2 Mattress Screen (Eleganza 5 with OptiCare)

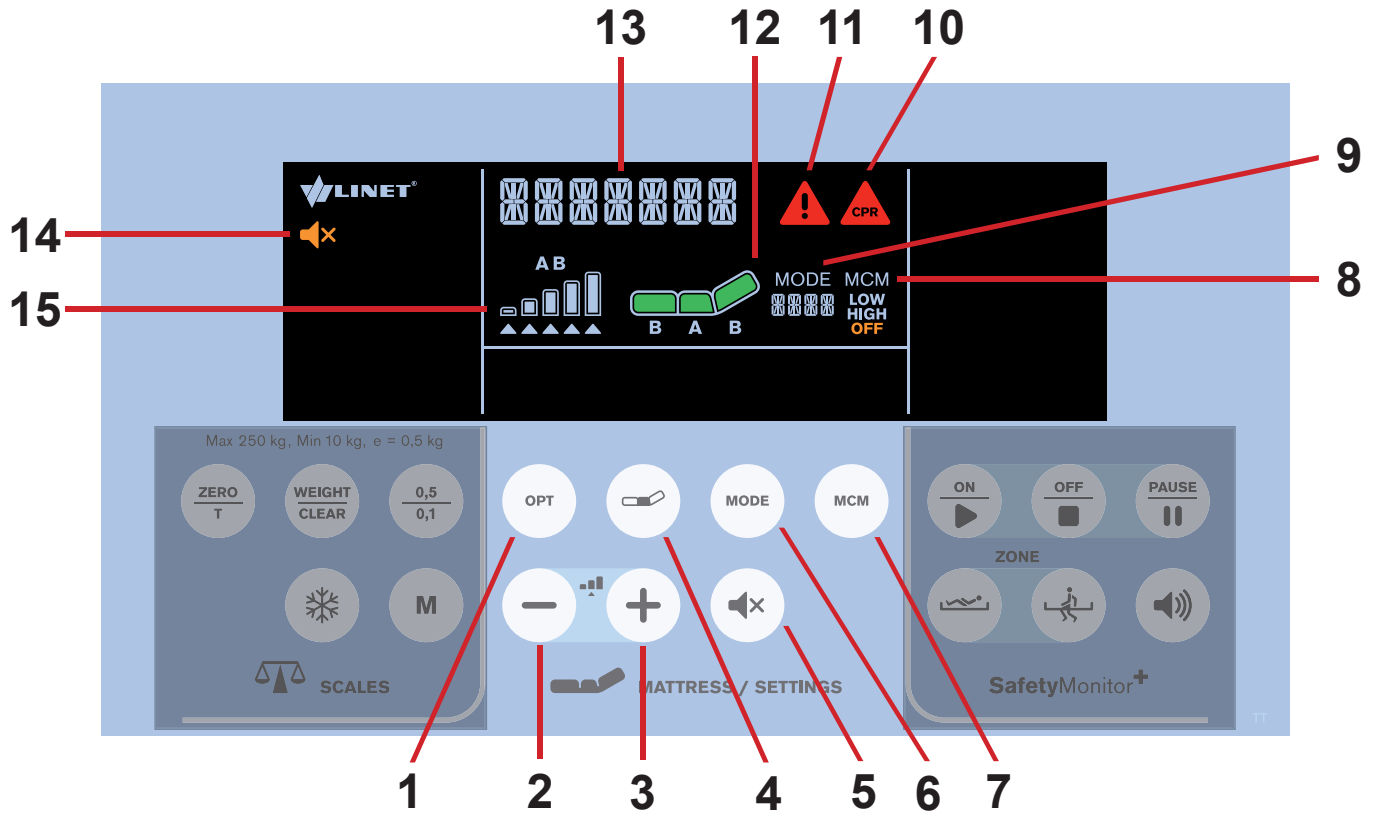



Fig. Mattress Display and Keyboard (iBoard Standard)

- | | |
|---------------------------------|-----------------------------|
| 1. OPT Mode Button | 9. Mode Icon with Mode Name |
| 2. MINUS Button | 10. Mattress CPR Alert Icon |
| 3. PLUS Button | 11. Alert Icon |
| 4. COMFORT Button | 12. Mattress Icon |
| 5. MUTE Button | 13. Status Indicator |
| 6. MODE Button | 14. MUTE Icon |
| 7. MCM Button | 15. Pressure Level Icon |
| 8. MCM Mode Icon (LOW/HIGH/OFF) | |

To mute compressor of the integrated mattress:

▶ Press button  .

Icon  indicates activated Mute Mode.

10.3 OptiCare Mattress Controls (Eleganza 5 with OptiCare)

Control and information on status of the OptiCare mattress is by the display and keyboard on the iBoard Standard.

Patient in bed detection (PIB)

Patient in bed detection system detects when a patient has entered or left the bed. This automatically starts the optimization process on patient ingress and puts the mattress into Standby mode on patient egress. During Standby mode mattress areas A and B are inflated to a static pressure. There is a short stable pressure detection delay before reacting to change in patient PIB status to prevent unnecessary mode changes because patient has changed position.

10.3.1 MATTRESS NOT INSTALLED

When OptiCare compressor is installed on the bed but OptiCare mattress is not connected to the compressor „MATTRESS NOT INSTALLED“ text appears on the display.

NOTE If the OptiCare mattress has been deliberately removed from the bed frame in order to use an alternative mattress then you must log out the OptiCare.

To connect OptiCare mattress to the compressor:

- ▶ connect each air pipe to the compressor.



Fig. Mattress Not Installed Screen

10.3.2 MATTRESS IDENTIFICATION

When OptiCare mattress is connected to the compressor and its identification starts „MATTRESS INSTALLED“ text is displayed and „MATTRESS IDENTIFICATION“ text is scrolling on the display.

NOTE Number on the place of Mode Name (9) indicates identification countdown.

To achieve identification of connected mattress:

- ▶ wait until identification countdown disappears.



Fig. Mattress Identification Screen

10.3.3 MATTRESS INFLATION

When OptiCare mattress is identified it is not prepared for a patient because mattress is not inflated enough. „MATTRESS INFLATION“ text is scrolling on the display.

NOTE Number on the place of Mode Name (9) indicates inflation countdown.

To achieve minimum inflation of the mattress:

- ▶ wait until inflation countdown disappears.



Fig. Mattress Inflation Screen

10.3.4 MATTRESS PREPARED FOR PATIENT

When „MATTRESS INFLATION“ text disappears and Mattress icon is fully green the mattress is ready for a patient.

NOTE Flashing Mattress Icon with selected OPT Mode indicates continuing inflation.

To use the mattress:

- ▶ position patient on the mattress.



Fig. MATTRESS PREPARED FOR PATIENT

10.3.5 PATIENT ON THE MATTRESS (OPT MODE)

Integrated Micro-Climate Management system will start working automatically with intensity set by MCM button when the patient gets into bed and stop if the patient gets out. As long as the patient remains on the mattress automatic optimization will continue. Optimization will occur if the patient's position changes sufficiently to trigger Optimization Detection or if initiated by the Optimization automatic timer.

NOTE During pressure optimization the Mattress icon is flashing. Fully green mattress icon indicates the mattress has achieved optimum pressure.

Optimization will stop working and the mattress air pressure will be set at a fixed level if

- ▶ the mattress support platform is tilted by 10 and more degrees (Anti-Trendelenburg Tilt)
 - ▶ the mattress support platform is tilted by 10 and more degrees (Lateral Tilt)
 - ▶ the mattress support platform is tilted by 5 and more degrees (Trendelenburg Tilt)
 - ▶ tilt reduction of the mattress support platform has value of 7 or less degrees (Anti-Trendelenburg Tilt)
 - ▶ tilt reduction of the mattress support platform has value of 7 or less degrees (Lateral Tilt)
 - ▶ tilt reduction of the mattress support platform has value of 3 or less degrees (Trendelenburg Tilt)
- In this case text „TILT NO OPT“ is displayed.

NOTE If at any time nursing staff feel it necessary to re-optimize the patient then this can be initiated manually by touching the button . This does not over-ride Optimization settings and this process will continue as before.

Manual pressure optimization:

- ▶ press button .

To set intensity of Micro-Climate Management:

- ▶ press button .

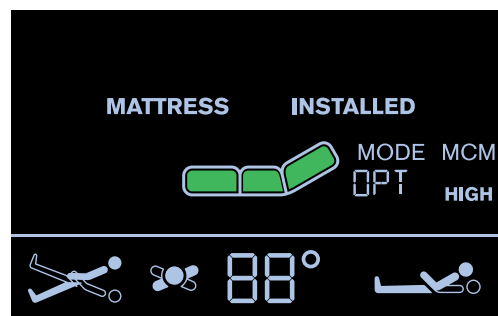

Fig. Patient On The Mattress

10.3.6 MAXIMUM MATTRESS INTERNAL PRESSURE

To set Maximum Mattress Internal Pressure:

- ▶ press button  until „MAX“ appears on the place of the Mode Name.

NOTE During inflation Mattress icon is flashing until it turns green.

NOTE During MAX mode text „MAX“ alternates with text indicating remaining minutes of the MAX mode (e.g. 30').

NOTE After 30 minutes the pressure optimization starts again. Countdown is displayed on the place of Mode Name (9).

NOTE Maximum Mattress Internal Pressure can be operated with or without a patient on the mattress.

NOTE To extend Maximum Mattress Internal Pressure you can press Mode Button again during last 5 minutes of the MAX Mode.

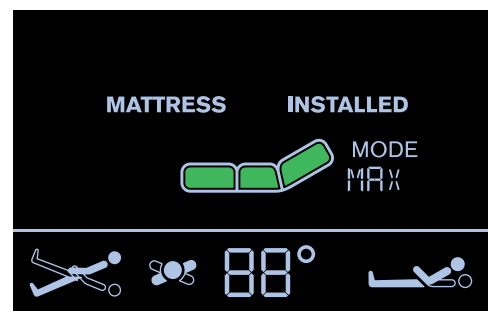





Fig. Maximum Mattress Internal Pressure

10.3.7 PRESSURE COMFORT ADJUSTMENT

The mattress pressure can be adjusted based on the patient's needs. The pressure can be separately adjusted in the Area **A** (seat section) or in the Area **B** (torso and leg mattress sections). The grey arrow below the Area **A** or Area **B** Pressure Level Icons indicates the optimized pressure.

To adjust pressure after pressure optimization:

- ▶ press button  to select Area **A** or **B**
- ▶ press button  or button  to adjust pressure in the selected Area (**A** or **B**)

NOTE Letter **A** or **B** under the Mattress Icon indicates the selected Area.

NOTE To remove these individual settings, press button  and the pressure levels go back to optimized pressure.

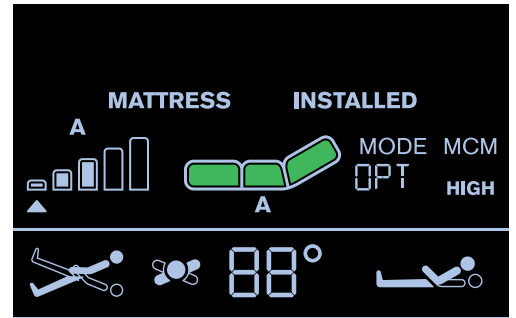

Fig. Pressure Comfort Adjustment

10.3.8 MICRO-CLIMATE MANAGEMENT (MCM MODE)

The Micro-Climate Management blows through the parts under the patient and removes moisture as one of the factors contributing to the development of pressure injuries.

To enter MCM Mode:

- ▶ press button  until **OFF** is not displayed under the **MCM** text.

To change intensity of MCM:

- ▶ press button  to set **LOW** or **HIGH** intensity of Micro-Climate Management.

LOW or **HIGH** is displayed under the **MCM** text in accordance with selected intensity level.

To turn off MCM Mode:

- ▶ press button  until **OFF** is displayed under the **MCM** text.

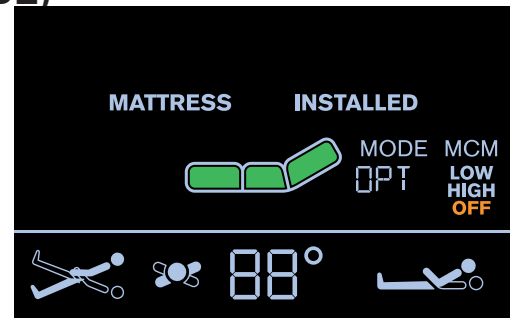



Fig. MCM Mode

10.3.9 CPR MODE (CPR ACTIVATED)

When CPR is activated the mattress will deflate and chest compression can start immediately.

NOTE During CPR mode text „CPR“ alternates with text indicating remaining minutes of the CPR mode (e.g. 60').

To activate CPR Mode:

- ▶ press button  in the Positioning Section of the iBoard Standard.

To deactivate CPR Mode:

- ▶ press button  or button .

The mattress will inflate again and return to the mode it was in before CPR started.

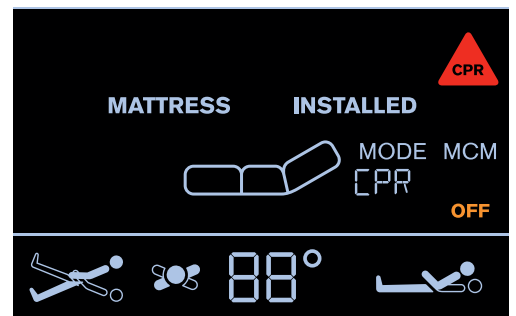

Fig. CPR Mode

10.3.10 ALERTS

UNPLUGGED

When the power cable is unplugged or mains power fails, the screen will show the following alert and „POWER“ text is scrolling on the display. This alert will automatically disappear when mains power is restored.

NOTE Red triangle with exclamation mark is displayed during this alert.

To eliminate this alert:

- ▶ connect the power cable to the socket!

TILT NO OPT

Pressure Optimization is stopped and text „TILT NO OPT“ is displayed when

- ▶ the mattress support platform is tilted by 10 and more degrees (Anti-Trendelenburg Tilt)
- ▶ the mattress support platform is tilted by 10 and more degrees (Lateral Tilt)
- ▶ the mattress support platform is tilted by 5 and more degrees (Trendelenburg Tilt)
- ▶ tilt reduction of the mattress support platform has value of 7 or less degrees (Anti-Trendelenburg Tilt)
- ▶ tilt reduction of the mattress support platform has value of 7 or less degrees (Lateral Tilt)
- ▶ tilt reduction of the mattress support platform has value of 3 or less degrees (Trendelenburg Tilt)

AUTOMATIC CALIBRATION

Text „AUTOMATIC CALIBRATION“ is displayed during the Automatic Calibration.

Automatic Calibration is automatically interrupted during intervention of patient or hospital staff.

If the Automatic Calibration is interrupted it will appear again after 10 hours.

To finish the Automatic Calibration:

- ▶ wait until the Automatic Calibration ends.

MATTRESS ERROR

When red triangle with exclamation mark appears on the display and „MATTRESS ERROR“ text is scrolling on the display mattress has a system error. The number next to the „MATTRESS ERROR“ text is linked to the type of error.

To eliminate an error:

- ▶ note down the number and contact service department approved by the manufacturer immediately!

To mute audio alarm:

- ▶ press button  .

To reset audio alarm:

- ▶ press and hold button  .

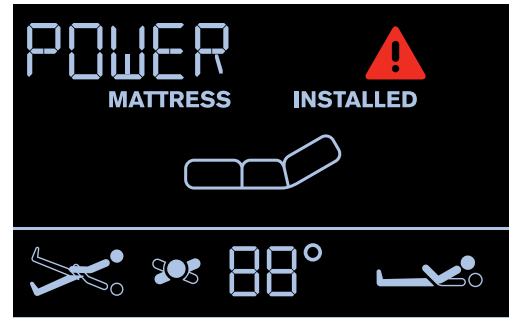

Fig. UNPLUGGED

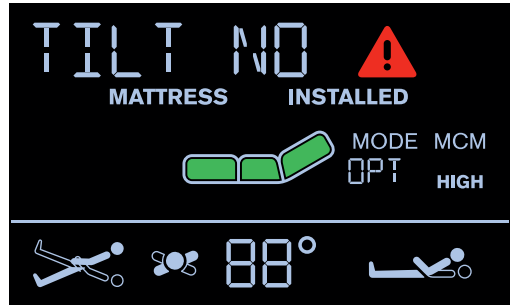

Fig. TILT NO OPT (Optimization disabled)

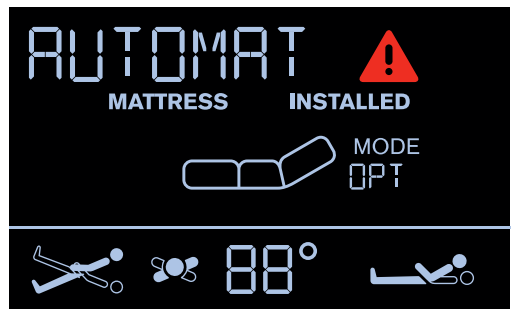

Fig. AUTOMATIC CALIBRATION



Fig. MATTRESS ERROR

DISCONNECTED AIR PIPES

If either the red, yellow or black air pipe is disconnected from the System Control Unit the following alert appears on the display. „MATTRESS DISCONNECTED“ text is scrolling on the display.

NOTE Red triangle with exclamation mark is displayed during this alert and audio alarm sounds.

NOTE Blue air pipes disconnected from the Sytem Control Unit do not cause this alert!

To remove this alert:

- ▶ check and reconnect each air pipe to the compressor!

CLOSE CPR

When CPR valve is opened and the mattress is inflating this alert appears.

NOTE Red triangle with „USE MANUAL CPR“ text is displayed during this alert.

To remove this alert:

- ▶ close CPR valve manually!

COMPRESSOR (SCU) NOT CONNECTED

When SCU is removed from the bed or communication between the bed and the SCU is lost this alert appears with „PUMP DISCONNECTED“ text.

NOTE There is red triangle with exclamation mark on the display during this alert.

To remove this alert:

- ▶ install compressor on the bed!



Fig. DISCONNECTED AIR PIPES



Fig. CLOSE CPR MANUALLY



Fig. PUMP DISCONNECTED

only OptiCare for Multicare

11 Putting into Service (only OptiCare for Multicare)



WARNING!

Risk of injury when working on the OptiCare integrated mattress replacement system!

- ▶ Ensure that the Multicare bed is disconnected from the mains connection prior to putting OptiCare integrated mattress replacement system into service, putting it out of service and maintenance.
- ▶ Ensure that the castors are locked prior to putting OptiCare integrated mattress replacement system into service, putting out of service and maintenance.



CAUTION!

Material damage due to incorrect putting into service!

- ▶ Ensure that putting into service is performed exclusively by manufacturer's customer service or trained hospital personnel.

The OptiCare mattress replacement system replaces any mattress on the Multicare bed frame.

- ▶ Remove any existing mattress.
- ▶ Put mattress on the Mattress support platform with air pipes at foot end of the bed.
- ▶ Connect Air Pipes to SCU observing colour code.
- ▶ Make sure that the CPR valves on both sides of the head end of the mattress are not left open but connected and accessible to manipulation.

NOTE During first installation of the mattress CPR valve is open!

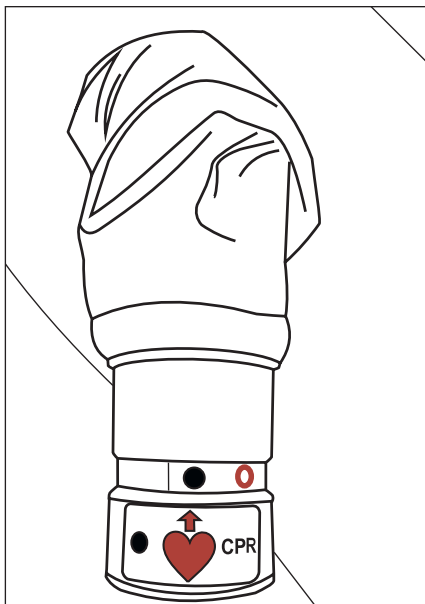

Fig. Closed CPR valve

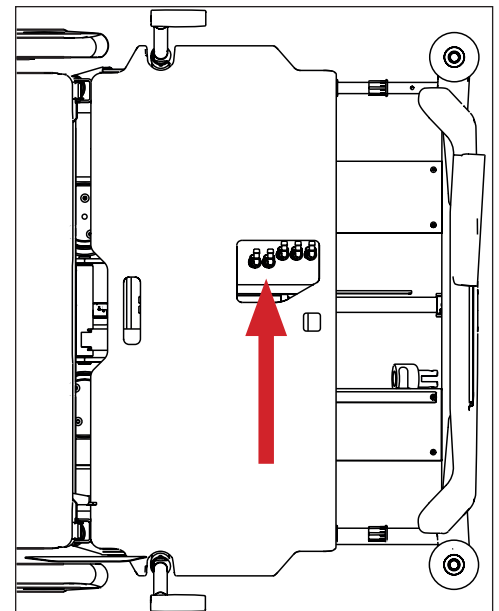

Fig. SCU with Air Pipes

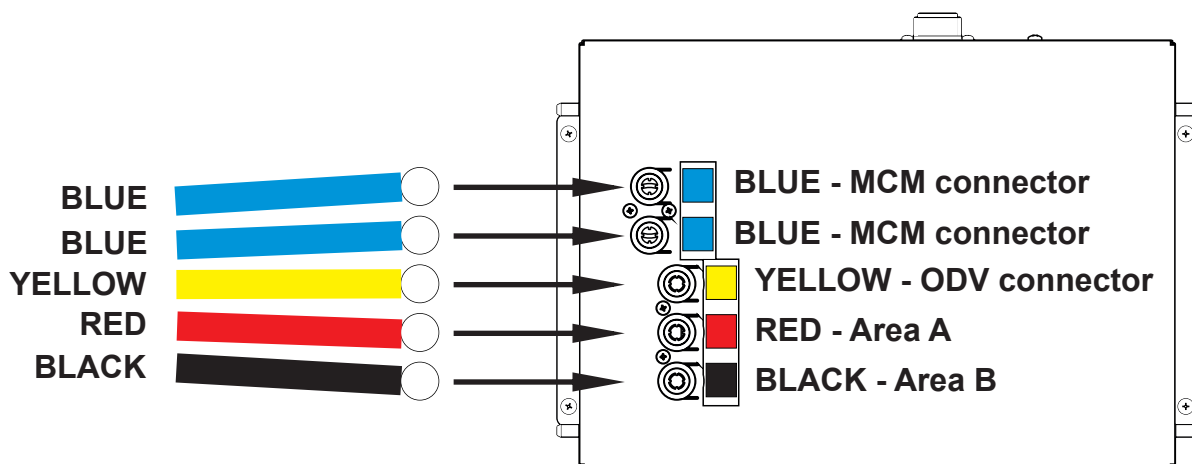

Fig. Air Pipes and SCU with Air Pipe Connectors

11.1 Mattress Installation



CAUTION!

Risk of material damage due to an incorrect fixation of OptiCare mattress on the mattress support platform!

- ▶ Adjust the bed to maximum Cardiac Chair Position before fixing all the straps of the inflated mattress to the mattress support platform!

To fix mattress on the Mattress Support Platform:

- ▶ Run three straps under the upper crossbar of Backrest frame and under the lower crossbar of Calftrest frame according to the picture below.
- ▶ Lock the three side release buckles by connecting their male and female parts together.

To remove mattress from the Mattress Support Platform:

- ▶ Release the three buckles by pressing them from both sides and by disconnecting their male and female parts.
- ▶ Pull these three straps out of the Mattress Support Platform.
- ▶ Remove mattress from the Mattress Support Platform.

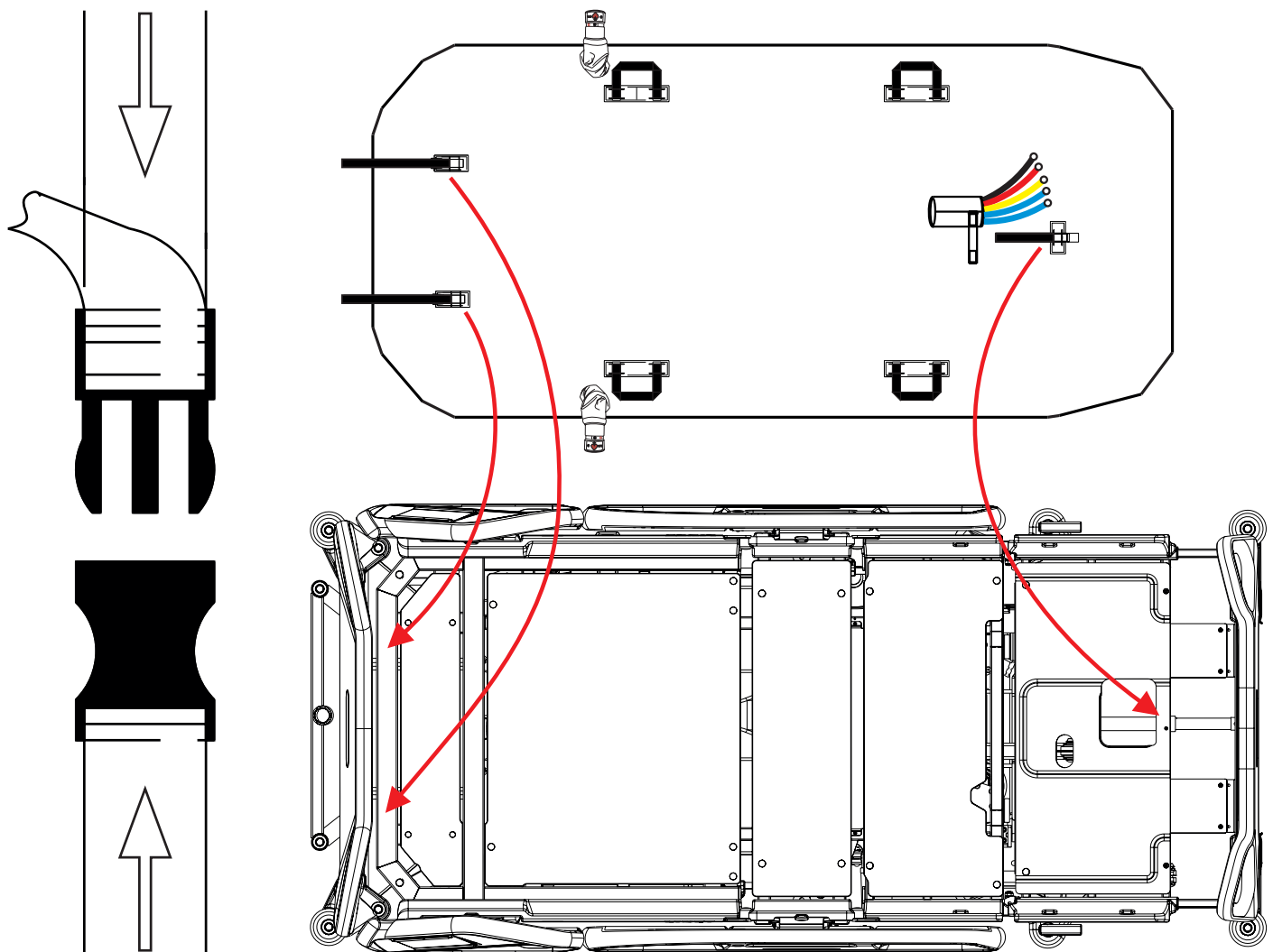

Fig. Fixation of the OptiCare mattress with straps on the mattress support platform of Multicare bed

11.2 SCU (System Control Unit)



WARNING!

OptiCare mattress is compatible with System Control Unit delivered by manufacturer only!

- ▶ Do not use any other System Control Unit with OptiCare mattress!



CAUTION!

Material damage due to incorrect installation of SCU!

- ▶ If the SCU does not come factory-fitted, have it installed by a service engineer authorised by LINET ®.

Mattress Detection System (MDS)

Sensors in the System Control Unit (SCU) Area A, B and ODV mattress air connectors detect that a valid air connector has been connected. When all three correct air connectors are detected, the SCU will enter Standby mode. In Standby mode mattress areas A and B are inflated to a static pressure ready for a patient to be placed onto the mattress and Optimization to start.

11.3 Replacing the mattress

When replacing the OptiCare mattress with an alternative active mattress from the LINET integrated systems, the system will automatically detect that type of mattress that has been connected and switch to the correct Multiboard control screen. If replacing the OptiCare mattress with one that is not from the LINET integrated systems range then you will need to cancel the Mattress Not Connected alarm.

Logging out the OptiCare:

When replacing the OptiCare mattress by a mattress that is not part of the LINET OptiCare integrated mattress range, it is necessary to log out OptiCare.

- ▶ Press and hold **Mattress OFF Icon** on the Settings Screen.
- ▶ Cancel the MATTRESS NOT CONNECTED alarm.

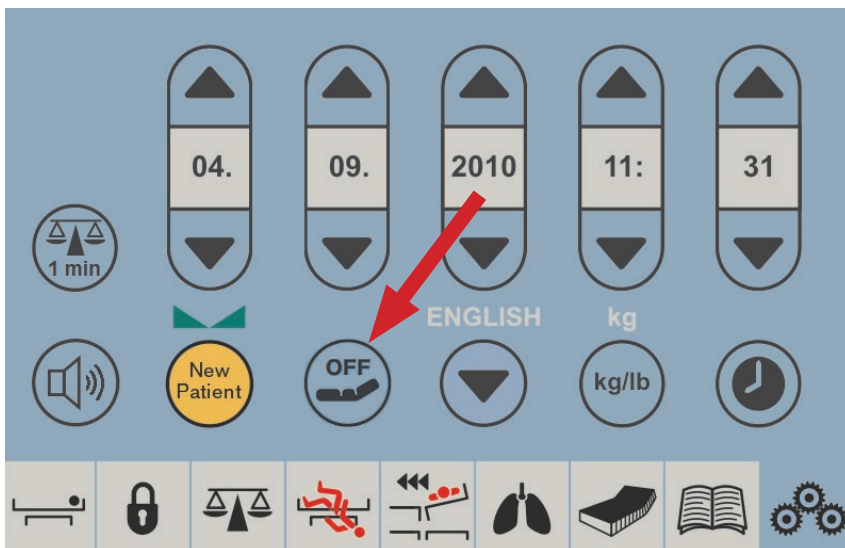

Fig. Mattress OFF Icon on the Settings Screen

12 Manipulation (OptiCare for Multicare)

Preparing OptiCare for patient



DANGER!

Risk of suffocation due to air-impermeable mattress cover!

- ▶ Use mattress cover correctly.
- ▶ The nursing staff are responsible for the safety of the patient on the mattress cover.



WARNING!

Risk of injury when positioning patient on the bed!

Before positioning the patient on the bed:

- ▶ Ensure that mattress is completely and correctly inflated.
- ▶ Ensure that mattress is correctly secured with safety straps.



CAUTION!

Material damage due to dampness or contamination!

- ▶ Make sure mattress cover has been cleaned and is completely dry (see Cleaning/ Disinfection).

Preparation

- ▶ Inflate mattress.
- ▶ Put a sheet loosely on the mattress if not prescribed otherwise by qualified personnel.

Positioning the Patient on the Bed

- ▶ Put the patient on the mattress. Patient must be put to the centre of mattress support platform.

Create the ideal patient position:

- ▶ If additional blankets or sheets are used, make sure that ease of movement is sufficient.
- ▶ Ensure that blankets, sheets, clothing etc. do not cause pressure injuries (e.g. due to creases, seams etc.).
- ▶ Do not place any additional sheets, blankets etc. between mattress and patient.

Patient's position on the mattress

**WARNING!****Risk of injury due to incorrect use!**

- ▶ Regularly check patient's position on the mattress! Patient must be put to the centre of mattress support platform in horizontal position! Head of a lying patient must point towards the bed head end. Position of patient's hip joints above the bed seat section must be in accordance with arrow-like symbols on the inner sides of the Head Board and Foot Board. Ensure the patient's hip joints are located between the arrow-like symbols on the inner sides of the Foot Siderails.
- ▶ Adjust bed extension according to patient's needs if a patient sitting in bed with lifted Backrest touches the bed Foot Board by his or her foot or feet.
- ▶ Do not move a patient back towards bed head end if the patient is sliding on the mattress during lifting of the Backrest.

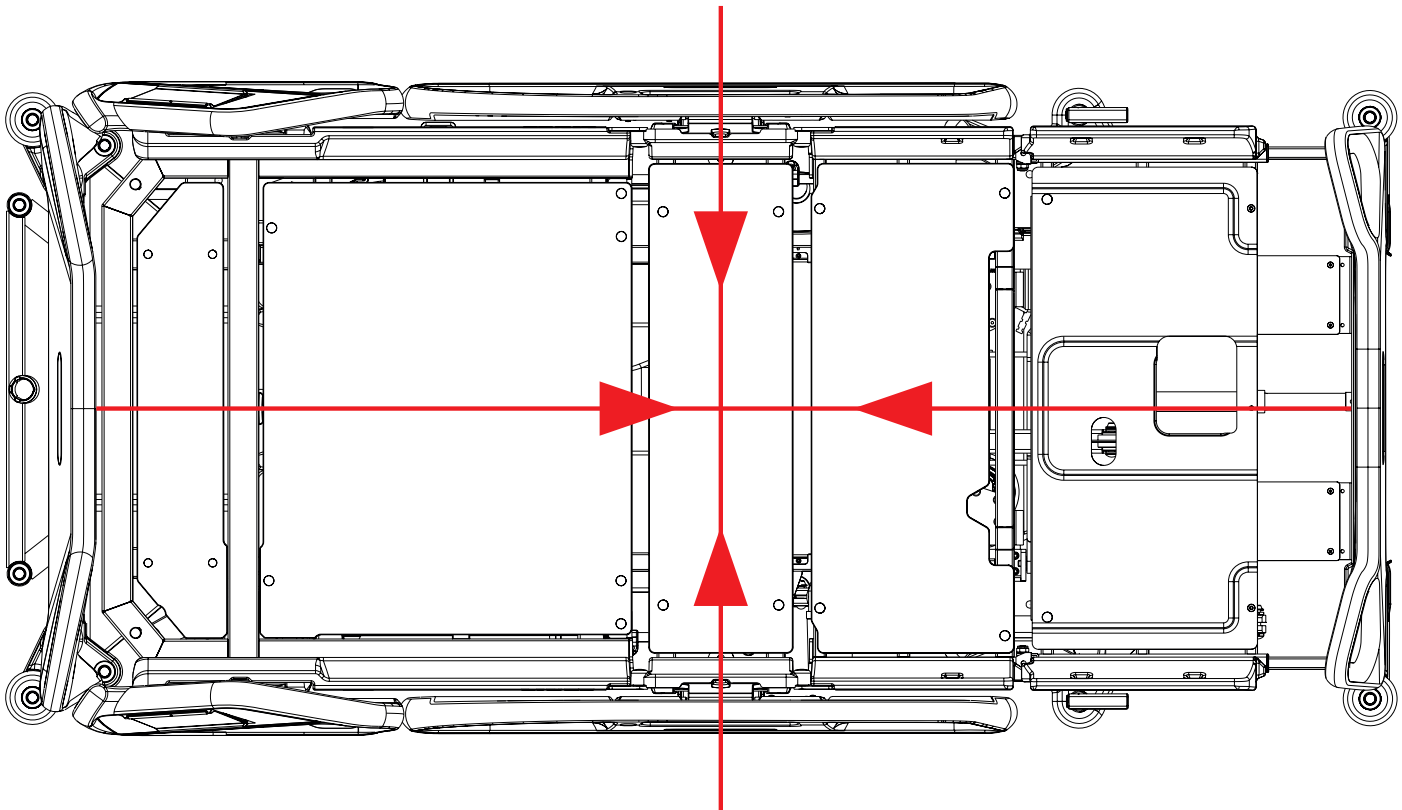

Fig. Instructions for finding the bed centre where patient must be located on the mattress

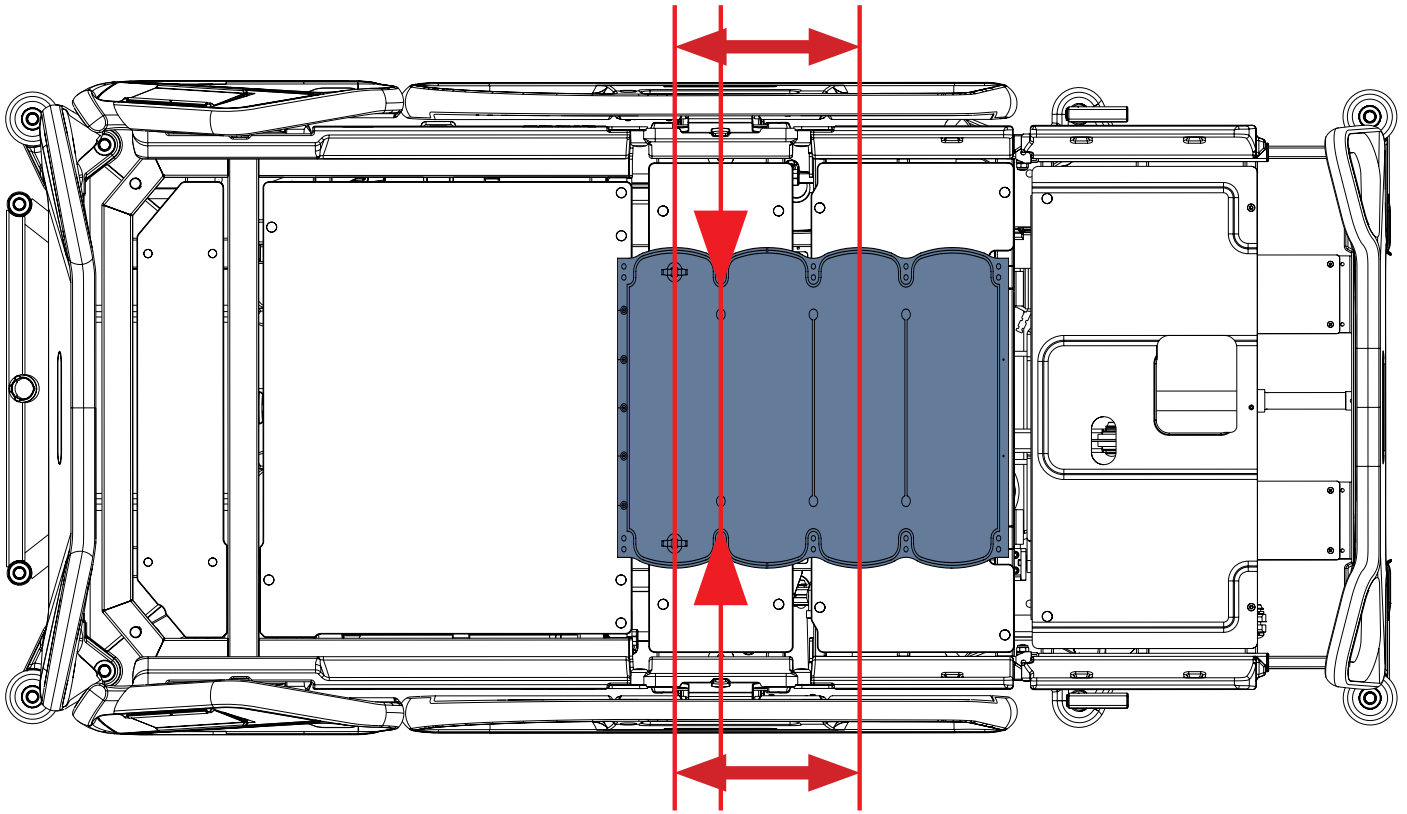

Fig. Area where patient's hip joints must be located on the mattress

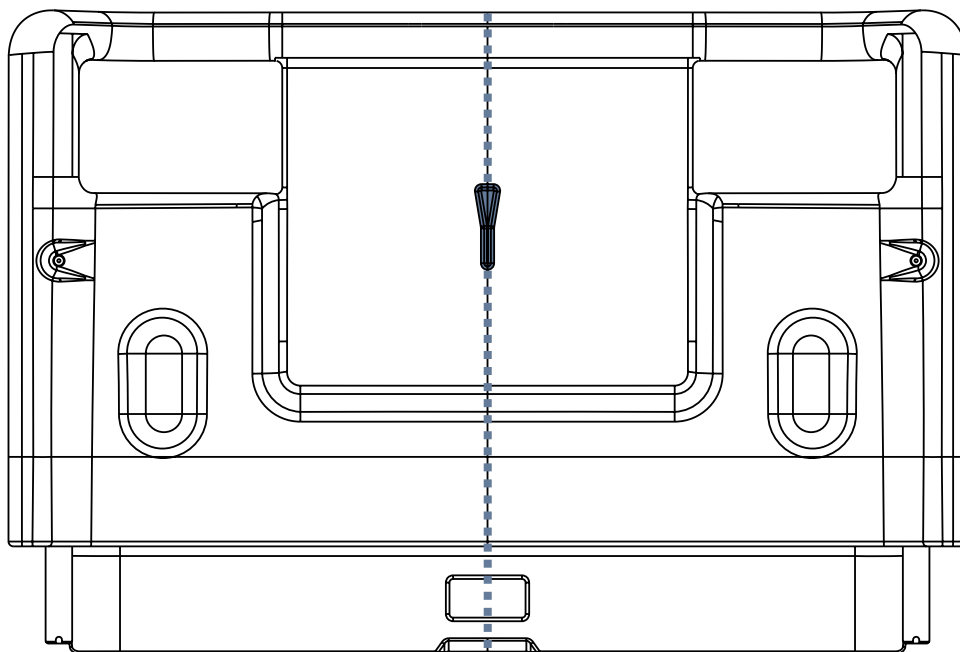

Fig. Inner side of Head Board with the arrow-like symbol indicating the centre of mattress support platform

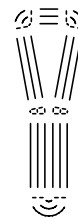

Fig. Arrow-like symbol on the inner sides of the Head Board and Foot Board and on the inner sides of the Foot Siderails indicating the centre of mattress support platform

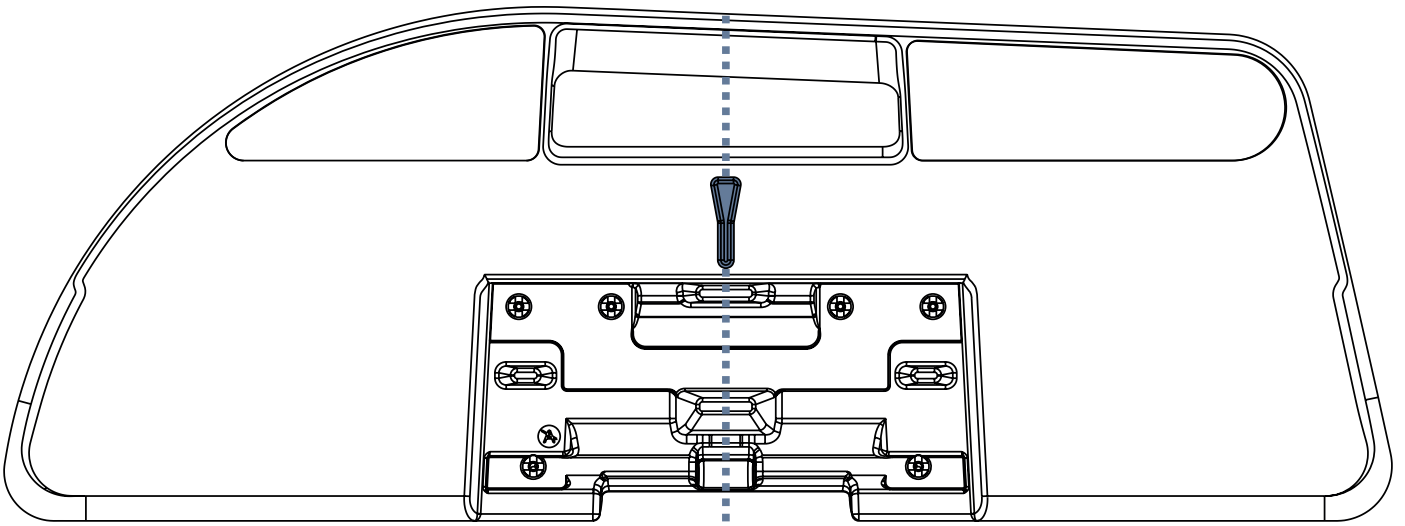

Fig. Inner side of Foot Siderail with the arrow-like symbol indicating the centre of mattress support platform

12.1 Manual CPR (during Transport or Power loss)

OptiCare is equipped with CPR valve on both sides next to the Manual Backrest Release.

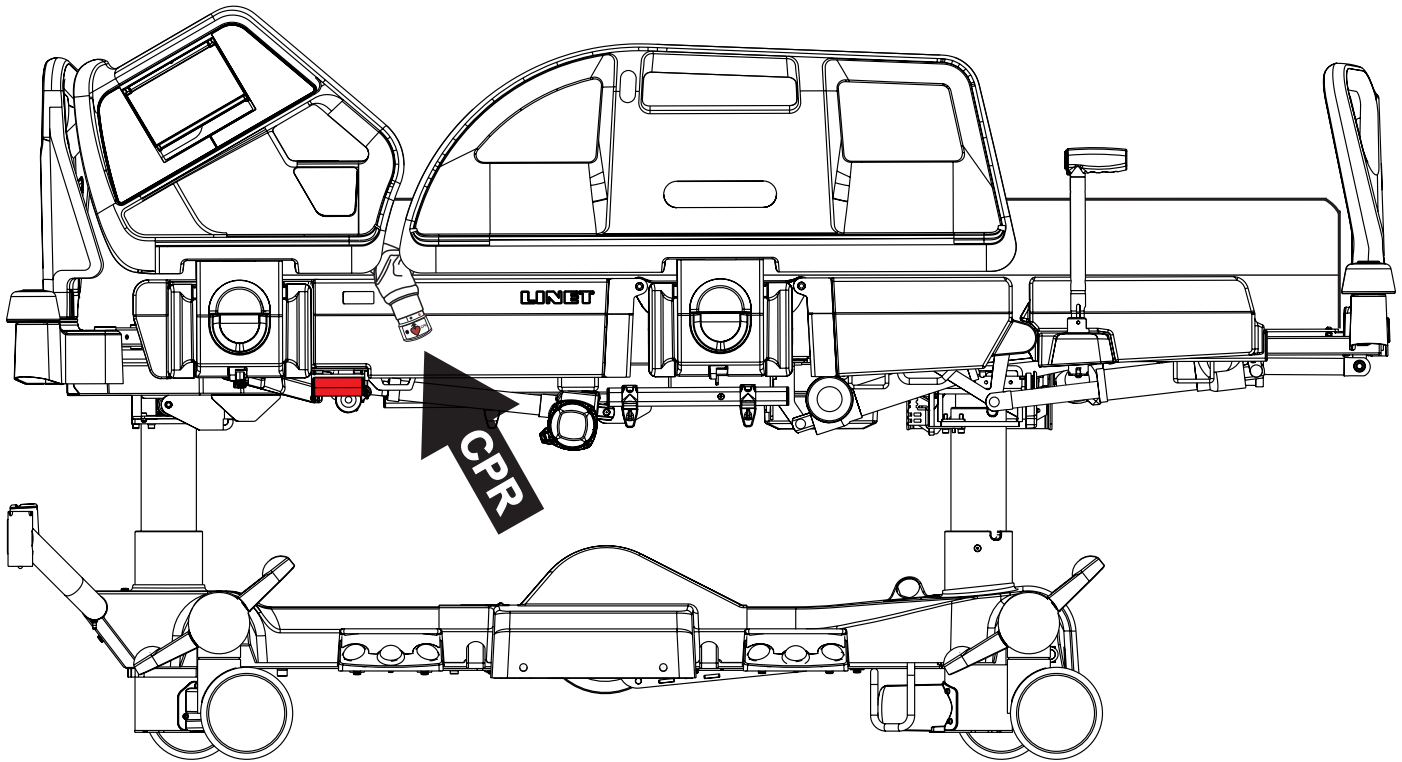

Fig. Position of the CPR valve on the OptiCare integrated mattress placed on the Eleganza 5 bed

To activate manual CPR:

- ▶ Open CPR valve on patient's left- or right-hand side by turning the end of CPR valve to the right and aligning the CPR red heart with the red circle.
- ▶ The mattress will deflate.
- ▶ The mattress support platform will flatten if bed CPR lever is used with opening of the mattress CPR valve.

NOTE The Mattress support platform will not enter the CPR position unless the CPR Button on the Multiboard is also pressed and held until the correct position has been reached.

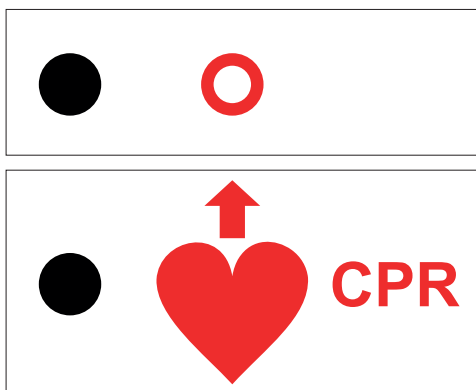

Fig. OPEN CPR VALVE

12.2 Automatic CPR (Multicare with OptiCare)

Cardiopulmonary Resuscitation Mode causes the mattress to deflate completely to facilitate resuscitation of patient. Typical deflation time for OptiCare is 15 seconds (max. 30 s). After 55 minutes of CPR Mode there will be an audio alarm every 30 seconds. After 60 minutes system will return to OPT Mode or MAX Inflate Mode.



Fig. CPR button

To activate the CPR Mode:

- ▶ Press and hold CPR button on Multiboard for at least 3 s.
- ▶ The mattress platform will straighten up.

The mattress deflates completely and mattress support platform will enter the CPR position.

NOTE: It is possible to use ACP also to activate CPR Mode.

12.3 Mattress Screen (Multicare with OptiCare)

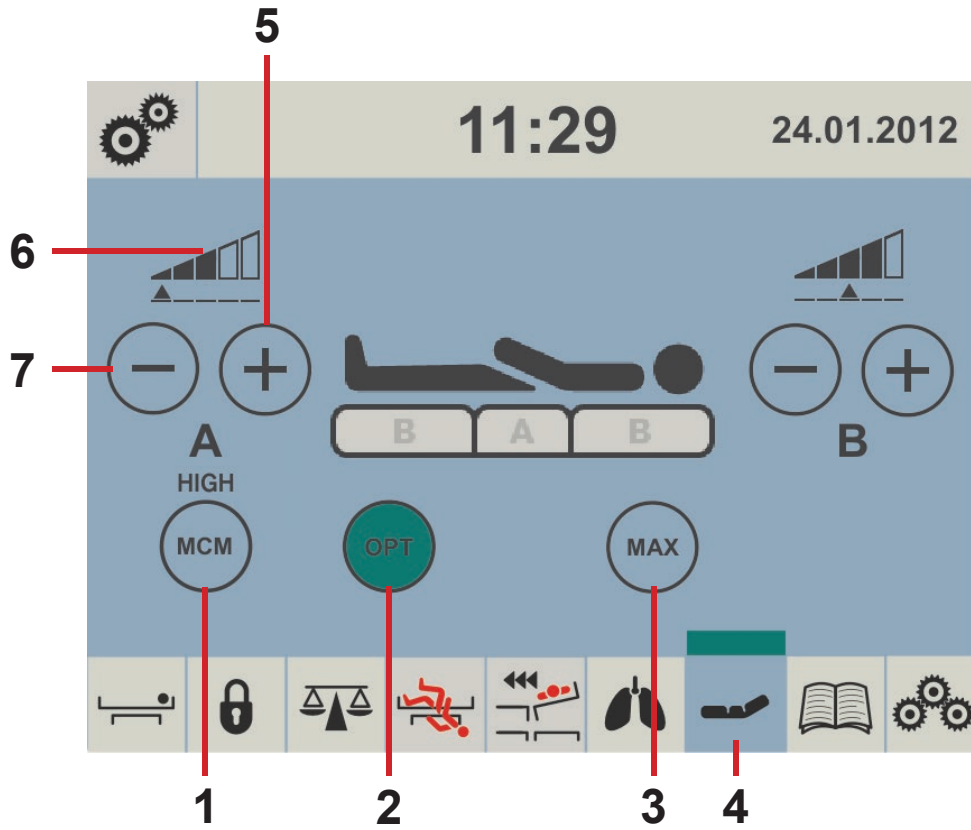

Fig. Mattress Screen (Multiboard)

1. MCM Mode Icon (LOW/HIGH/OFF)
2. OPT Mode Button
3. MAX Mode Button
4. Mattress Screen Icon (to enter Mattress Screen)
5. PLUS Button (+)
6. Pressure Level Icon
7. MINUS Button (-)

12.4 OptiCare Mattress Controls (Multicare with OptiCare)

Control and information on status of the OptiCare mattress is by the display and keyboard on the Multiboard.

Patient in bed detection (PIB)

Patient in bed detection system detects when a patient has entered or left the bed. This automatically starts the optimization process on patient ingress and puts the mattress into Standby mode on patient egress. During Standby mode mattress areas A and B are inflated to a static pressure. There is a short stable pressure detection delay before reacting to change in patient PIB status to prevent unnecessary mode changes because patient has changed position.

12.4.1 MATTRESS NOT CONNECTED

When OptiCare compressor is installed on the bed but OptiCare mattress is not connected to the compressor „MATTRESS NOT CONNECTED“ screen appears.

NOTE: Red strip above the mattress icon is flashing in this screen.

NOTE: If the OptiCare mattress has been deliberately removed from the bed frame in order to use an alternative mattress then you must log out the OptiCare.

To connect OptiCare mattress to the compressor:

- ▶ connect each air pipe to the compressor.



Fig. Mattress Not Connected Screen

12.4.2 MATTRESS IDENTIFICATION

When OptiCare mattress is connected to the compressor and its identification starts „Mattress Identification“ screen appears.

NOTE: Number above the text „MATTRESS IDENTIFICATION“ indicates identification countdown.

To achieve identification of connected mattress:

- ▶ wait until identification countdown disappears.



Fig. Mattress Identification Screen

12.4.3 MATTRESS INFLATION

When OptiCare mattress is identified it is not prepared for a patient because mattress is not inflated enough.

NOTE: Number above the text „MATTRESS INFLATION“ indicates inflation countdown.

- To achieve minimum inflation of the mattress:**
- ▶ wait until inflation countdown disappears.



Fig. Mattress Inflation Screen

12.4.4 MATTRESS PREPARED FOR PATIENT

When red cross over the mattress patient icon disappears the mattress is ready for a patient.

NOTE: Flashing OPT icon indicates continuing inflation.

- To use the mattress:**
- ▶ position patient on the mattress.

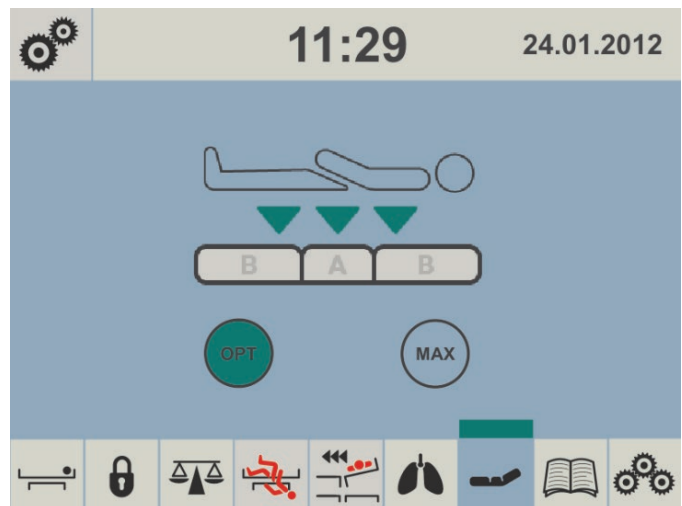

Fig. Mattress Prepared for Patient

12.4.5 PATIENT ON THE MATTRESS

When there is a patient on the mattress patient icon turns to black color. As long as the patient remains on the mattress automatic optimization will continue. Optimization will occur if the patient’s position changes sufficiently to trigger Optimization Detection or if initiated by the Optimization automatic timer. The integrated Micro-Climate Management system will start working automatically when the patient gets into bed and stop if the patient gets out.

NOTE: During pressure optimization the OPT icon is flashing. Fully green OPT icon and green strip above mattress icon indicate mattress has achieved optimum pressure.

Optimization will stop working and the mattress air pressure will be set at a fixed level if

- ▶ the mattress support platform is tilted by 10 and more degrees (Anti-Trendelenburg Tilt)
- ▶ the mattress support platform is tilted by 10 and more degrees (Lateral Tilt)
- ▶ the mattress support platform is tilted by 5 and more degrees (Trendelenburg Tilt)
- ▶ tilt reduction of the mattress support platform has value of 7 or less degrees (Anti-Trendelenburg Tilt)
- ▶ tilt reduction of the mattress support platform has value of 7 or less degrees (Lateral Tilt)
- ▶ tilt reduction of the mattress support platform has value of 3 or less degrees (Trendelenburg Tilt)



NOTE: If at any time nursing staff feel it necessary to re-optimize the patient then this can be initiated manually by touching the OPT icon. This does not over-ride Optimization settings and this process will continue as before.

Manual pressure optimization:

- ▶ press OPT icon.

To reduce intensity of Micro-Climate Management:

- ▶ press MCM icon until lower intensity is displayed above the icon.

Fig. Patient on the Mattress

12.4.6 MAXIMUM MATTRESS INTERNAL PRESSURE

To set Maximum Mattress Internal Pressure:

- ▶ press MAX icon.

NOTE: During inflation MAX icon is flashing until it turns yellow.

NOTE: After 30 minutes the pressure optimization starts again.

Countdown is displayed on the screen above MAX icon.

NOTE: Maximum Mattress Internal Pressure can be operated with or without a patient on the mattress.

NOTE: To extend Maximum Mattress Internal Pressure you can press MAX icon again.

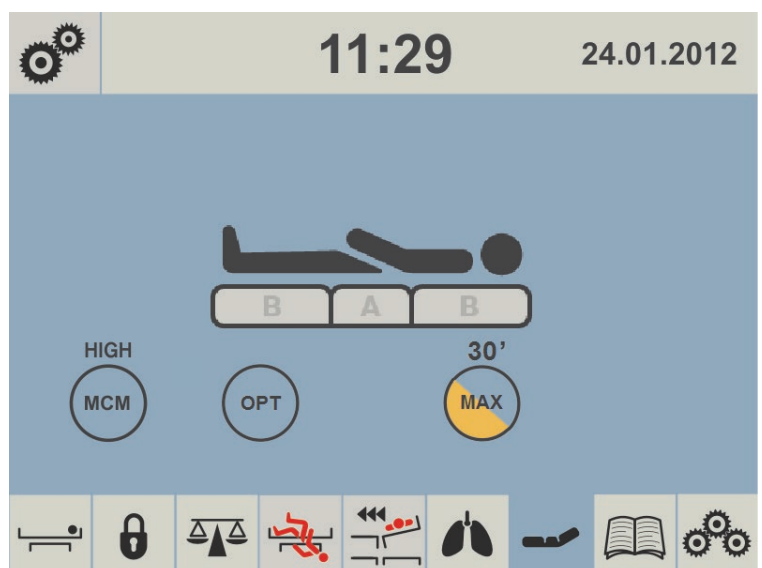

Fig. Maximum Mattress Internal Pressure

12.4.7 PRESSURE COMFORT ADJUSTMENT

The mattress pressure can be adjusted based on the patient's needs, press -+ icon. The pressure can be separately adjusted in the A section (seat section) or in the B section (torso and leg mattress areas). The black arrow below the A and B section level indicators indicates the optimized pressure.

To adjust pressure after pressure optimization:

- ▶ press - + icon
- ▶ press – icon or + icon according to the section to be adjusted (A or B)



Fig. Pressure Adjustment

12.4.8 MCM MODE

During MCM Mode it is possible to set intensity of Micro-Climate Management.

To set intensity of Micro-Climate Management:

- ▶ press MCM icon and repeat it until desired intensity is reached.

Each press of the MCM icon will step the option through its possible setting of LOW, HIGH and OFF.

NOTE: During MCM Mode it is possible to set Mattress Pressure Optimization (OPT), Maximum Mattress Internal Pressure (MAX) or adjust pressure with -+ icon if it is not disabled in Setting Screen.

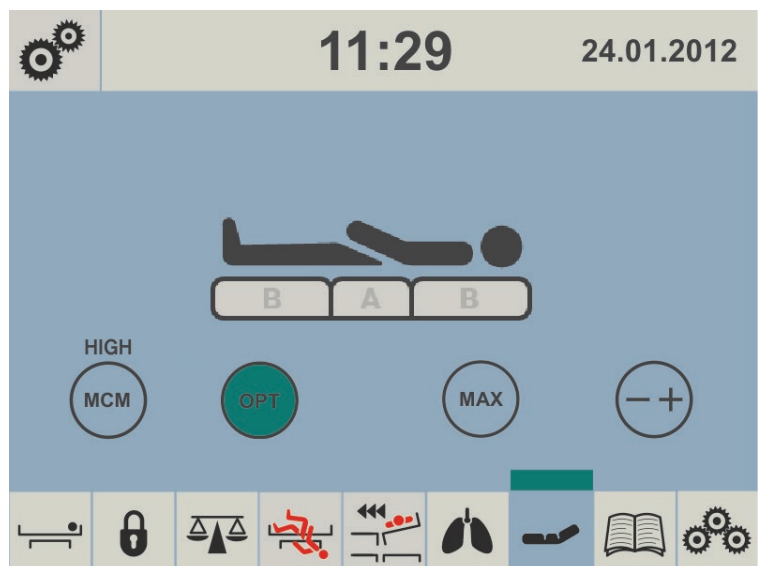

Fig. MCM Mode

12.4.9 CPR MODE (CPR ACTIVATED)

When CPR is activated the mattress will deflate and chest compression can start immediately.

NOTE: The countdown is displayed above the patient icon and indicates the amount of minutes the mattress stays deflated. Red strip with „CPR“ text appears above the mattress icon.

NOTE: EXIT CPR icon is optional. Service technician approved by manufacturer is allowed to display or hide this icon.

To deactivate CPR Mode:

- ▶ press EXIT CPR icon.

The mattress will inflate again and return to the mode it was in before CPR started.



Fig. CPR Activated

12.4.10 SETTING

Setting screen is used to enable or disable pressure (comfort) adjustment. To return to the mattress screen press either of the small mattress icons.

NOTE: A red cross over any icon means the function is disabled.

To enter Setting screen:

- ▶ press  icon.

To hide or unhide - + icon on the other screens:

- ▶ press COMF icon in the Setting Screen.

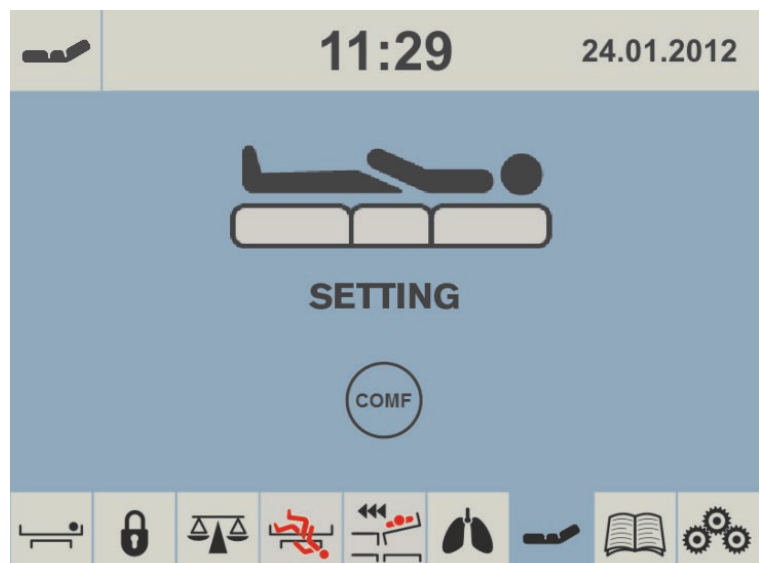

Fig. Setting Screen

12.4.11 ALERTS

UNPLUGGED

When the power cable is unplugged or mains power fails, the screen will show the following alert. This alert will automatically disappear when mains power is restored. Transport mode is activated automatically if no mains power is available to the SCU. Neither OPT Mode nor MCM Mode will be operational.

NOTE: Red strip above the mattress icon is flashing during this alert.

To eliminate this alert:

- ▶ connect the power cable to the socket!



Fig.Alert - Unplugged

ERROR

When a red triangle with exclamation mark appears in the screen the mattress has a system error. The number in the screen is linked to the type of error. Alerts are indicated also by an acoustic signal.

NOTE: Red strip above the mattress icon is flashing during this alert.

To eliminate an error:

- ▶ note down the number and contact service department approved by the manufacturer immediately!

To eliminate an acoustic alert:

- ▶ press  icon to mute the alert signal.

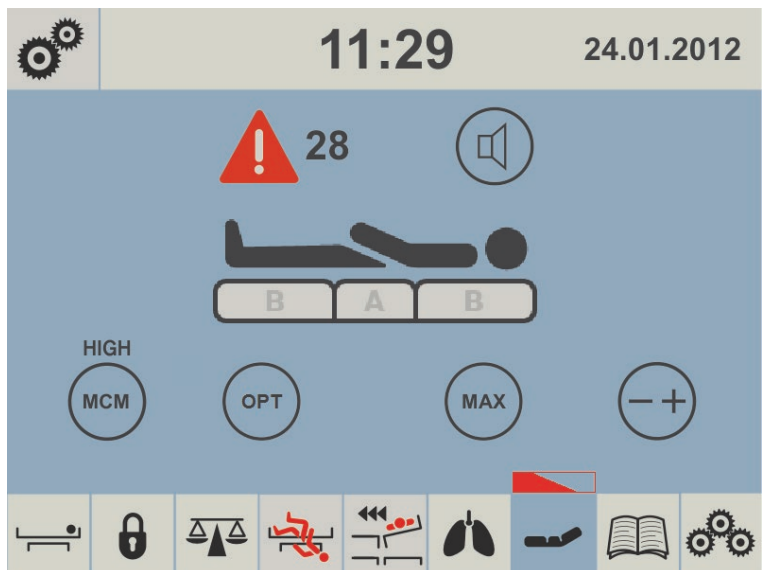

Fig.Alert - ERROR

DISCONNECTED AIR PIPES

If either the red, yellow or black air pipe is disconnected from the System Control Unit the following alert appears in the screen.

NOTE: Red strip above the mattress icon is flashing during this alert.

NOTE: Blue air pipes disconnected from the Sytem Control Unit do not cause this alert!

To remove this alert:

- ▶ check and reconnect each air pipe to the compressor!



Fig. Alert – Disconnected Air Pipes

CLOSE CPR

When CPR valve is opened and the mattress is inflating this screen appears.

NOTE: Red strip above the mattress icon is flashing during this alert.

To remove this alert:

- ▶ close CPR valve manually!



Fig. Alert – CLOSE CPR

AUTOMATIC CALIBRATION

Automatic Calibration occurs each 3 months.

Automatic Calibration is automatically interrupted during intervention of patient or hospital staff.

If the Automatic Calibration is interrupted it will appear again after 10 hours. Following screen appears during this process.

To finish the Automatic Calibration:

- ▶ wait until the Automatic Calibration ends.



Fig. Automatic Calibration

PRESSURE OPTIMISATION DISABLED

Pressure Optimization is stopped when:

- ▶ the mattress support platform is tilted by 10 and more degrees (Anti-Trendelenburg Tilt)
- ▶ the mattress support platform is tilted by 10 and more degrees (Lateral Tilt)
- ▶ the mattress support platform is tilted by 5 and more degrees (Trendelenburg Tilt)
- ▶ tilt reduction of the mattress support platform has value of 7 or less degrees (Anti-Trendelenburg Tilt)
- ▶ tilt reduction of the mattress support platform has value of 7 or less degrees (Lateral Tilt)
- ▶ tilt reduction of the mattress support platform has value of 3 or less degrees (Trendelenburg Tilt)

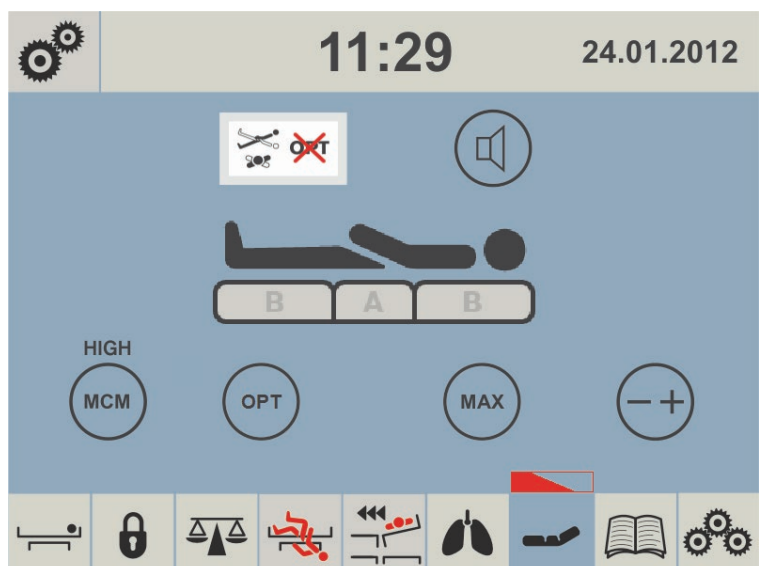

Fig. Pressure Optimisation Disabled

12.4.12 POP-UPS

COMPRESSOR (SCU) NOT CONNECTED

When SCU is removed from the bed or communication between the bed and the SCU is lost this POP-UP appears.

NOTE: There is red triangle on this screen instead of the mattress icon during this alert.

To remove this POP-UP:

- ▶ install compressor on the bed!

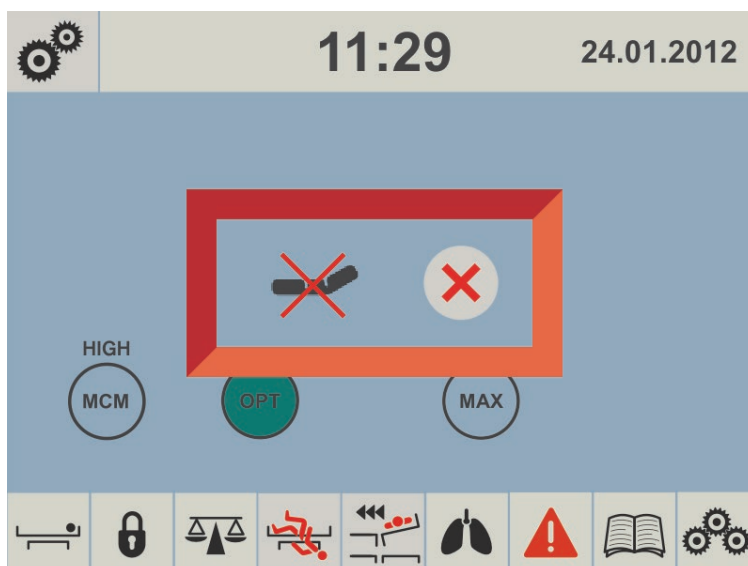

Fig. POP-UP – Compressor Not Connected

USE MANUAL CPR

When the CPR valves on the mattress sides needs to be activated to deflate mattress for CPR (e. g. during transport or when power supply is down) this pop-up will appear in the screen.



Fig. POP-UP – Use Manual CPR

13 Equipment

Product equipment depends on product configuration.

13.1 X-ray Pocket



CAUTION!
It is forbidden to wash the X-ray Pocket in the washing machine!

Mattress Cover ZONED and Mattress Cover ENDURANCE could be equipped with X-ray Pocket. The X-ray Pocket is accesible from the left side and from the right side of the OptiCare integrated mattress. The X-ray Pocket is connected to the mattress cover by zip so it can be removed from the mattress cover when it is completely unzipped.

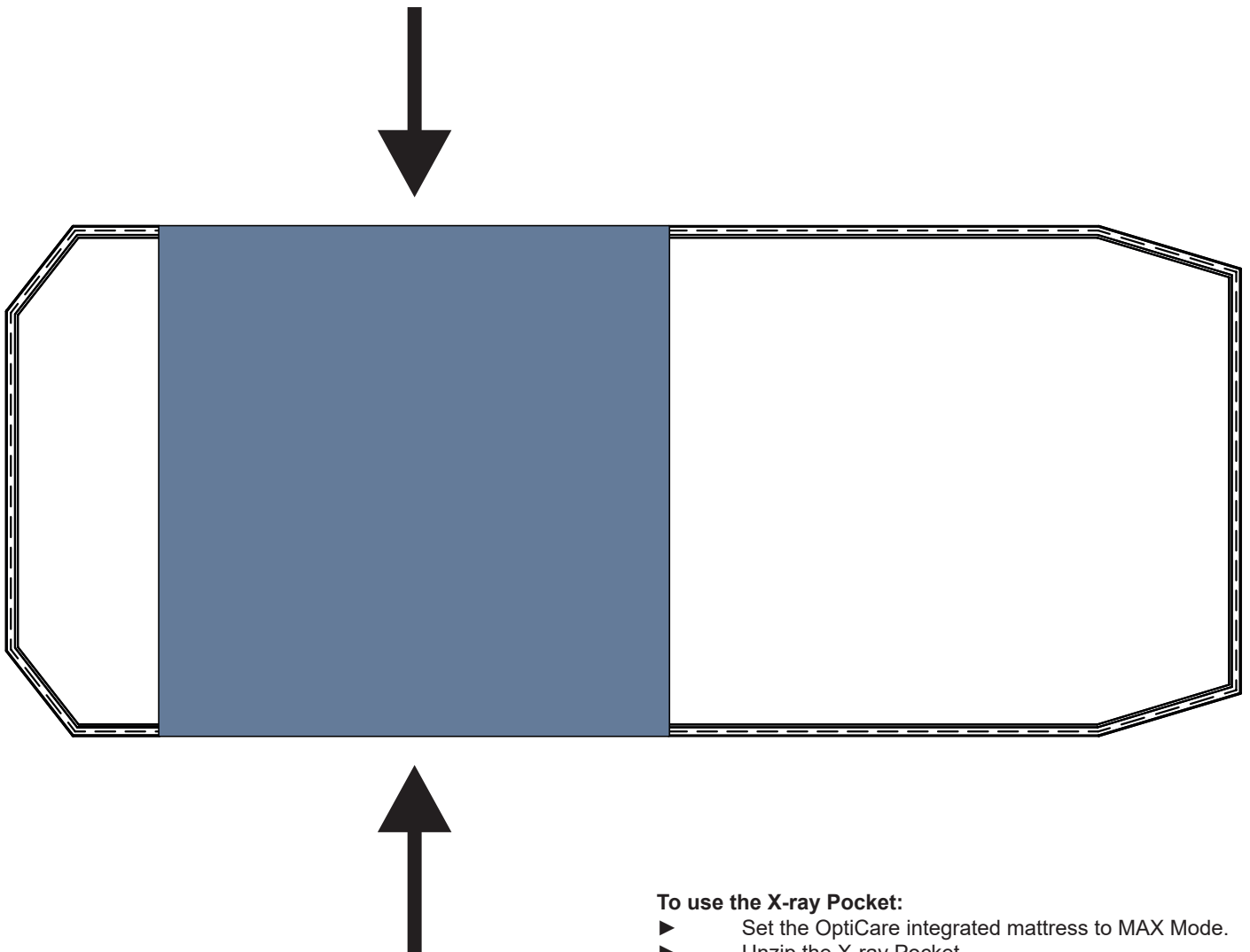

Fig. Access to the X-ray Pocket (mattress cover ZONED or mattress cover ENDURANCE)

To use the X-ray Pocket:

- ▶ Set the OptiCare integrated mattress to MAX Mode.
- ▶ Unzip the X-ray Pocket.
- ▶ Insert an X-ray cassette to the X-ray Pocket.
- ▶ Do the X-ray images.
- ▶ Remove the X-ray cassette from the X-ray Pocket.
- ▶ Zip the X-ray Pocket.
- ▶ Set the OptiCare integrated mattress to the previous mode.

13.2 Hercules ready OptiCare integrated mattress



WARNING!

The OptiCare integrated mattress compatible with Hercules Patient Repositioner is intended for use only with Multicare bed on which the Hercules Patient Repositioner is installed. The standard OptiCare integrated mattress compatible with Multicare bed is not compatible with Hercules Patient Repositioner! The OptiCare integrated mattress compatible with Hercules Patient Repositioner can be identified according to the Dream Air MIOB-44CVR Mattress Cover.



WARNING!

When utilizing the Morel Hercules system with the LINET OptiCare integrated mattress on the Multicare bed

- ▶ The combination of the LINET Multicare bed and Morel Hercules system cannot be sold outside of the United States of America.

- ▶ LINET authorized technician must install and confirm appropriate Hercules installation kit. Kits are bed specific, failure to utilize the appropriate kit could void the warranty and impact patient safety.
- ▶ During annual periodic preventative maintenance special attention must be paid to torque settings on attachment hardware.
- ▶ It is recommended that a spinal board be utilized under the patient during Cardiopulmonary Resuscitation (CPR).
- ▶ Patient lines and position must be monitored while utilizing the Hercules unit to boost the patient.
- ▶ If Hercules unit is removed from the LINET Multicare frame, the OptiCare integrated mattress must be replaced, and the gas spring be removed from the Backrest of the Multicare bed.



WARNING!

Do not use Hercules Patient Repositioner with a patient in prone position on the OptiCare integrated mattress!

Compatible configuration of the OptiCare integrated mattress can be used with Multicare bed equipped with Hercules Patient Repositioner. Hercules system shall be used when Multicare bed is in horizontal and flat position. Hercules system can be used only if OptiCare integrated mattress is in MAX Mode.

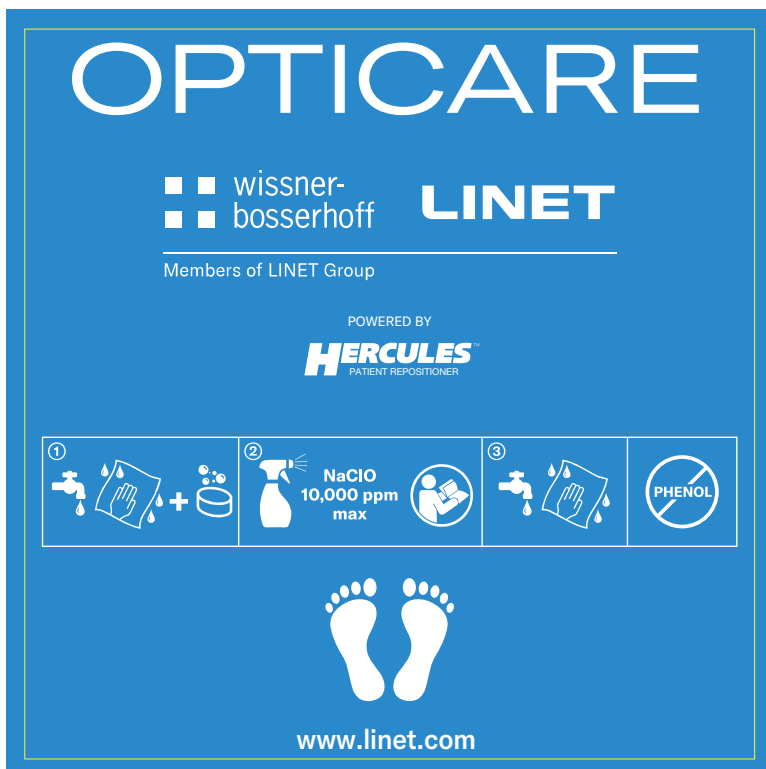

Fig. Dream Air MIOB-44CVR Mattress Cover (Identification of the OptiCare integrated mattress compatible with Hercules system)

In order to facilitate CPR on the Multicare bed equipped with OptiCare integrated mattress and Hercules Patient Repositioner:

- ▶ Use the CPR spinal board.
- ▶ After the CPR keep the spinal board until the OptiCare integrated mattress is inflated.

13.2.1 Mattress Cover Cleaning and Disinfection Instructions (Dream Air MIOB-44CVR)



WARNING!

Failure to properly rinse and dry the Mattress Cover can reduce the product's useful life! Failure to follow these instructions may void the mattress warranty!

Cleaning Instructions:

- ▶ Clean the Mattress Cover with a soft cloth dampened with a mild detergent and water.
- ▶ After, rinse with a warm washcloth to remove any residue.

Disinfecting Instructions:

- ▶ Disinfect the Mattress Cover with an EPA registered disinfectant appropriate for soft-sided materials and follow the manufacturer's recommended disinfecting instructions.
- ▶ Do not saturate the surface or allow the disinfectant to pool on the cover.
- ▶ Prior to the disinfectant drying, rinse the Mattress Cover with warm water and washcloth to remove any residue.

Drying Instruction:

- ▶ Let air dry.
- ▶ Do not use the mattress until it is thoroughly dry.

14 Cleaning/Disinfection (OptiCare)



CAUTION!

Material damage due to incorrect cleaning/disinfection!

- ▶ Do not use pressure or steam cleaners.
- ▶ Follow the instructions and observe the dosages recommended by the manufacturer.
- ▶ Ensure that disinfectants are selected and applied exclusively by qualified hygiene experts.

General guidance – Standard Cover:

- ▶ Do not use any strong acids or alkalines, (optimum pH range 6 – 8. Do not exceed pH of 9). Some hard surface cleaners have pH values outside this range, these are not suitable for use on coated textiles.
- ▶ Only use detergents that are suitable for cleaning medical equipment and for use on coated textiles.
- ▶ Do not use abrasive powders, steel wool, or other material and cleaning agents that might damage the mattress. Do not scrub mattress surface.
- ▶ Never use any corrosive or caustic detergents.
- ▶ Never use detergents that deposit calcium carbonate.
- ▶ Never use detergents with solvents that might affect the structure and consistency of the plastics (benzene, toluene, acetone, phenol, etc.).
- ▶ Use only hospital-approved cleaners and observe local directives concerning infection control.
- ▶ Always rinse with water after cleaning and dry thoroughly before use.

Mattress parts to be cleaned	Recommended Cleaning Agents (General cleaning)
Top Cover High MVP (Moisture Vapor Permeable) Material	Standard hospital detergents, Alcohol or Quaternary Ammonium based disinfectants, Chlorine based disinfectants containing up to 1000ppm Chlorine, followed by rinsing with water and drying thoroughly before use.
	Decontamination: Blood spills/Clostridium difficile etc Chlorine based disinfectants containing up to 10,000 ppm Chlorine. Dwell time on surface at 10,000 ppm of 2 minutes, followed by rinsing with water and drying thoroughly before use.
Base Cover, Air Cells, Foam Base	As procedures above.

Due to the variety of laundry equipment, chemicals and conditions in use, customers should satisfy themselves through pre-testing. It is essential that articles be thoroughly rinsed and dried after all cleaning procedures and before storage or reuse. Wet or damp PU surfaces are more prone to mechanical damage than when dry.

As stated above, after application of a suitable cleaner, the surface must be rinsed with water and dried before use. (Even if the cleaner instructions say that this is not required). This prevents a build up of chemicals on the mattress surface which could be reactivated during use and affect biocompatibility. The High MVP Coating may swell and change appearance during cleaning. This will recover after being thoroughly dried.

NOTE Continued use of high concentration, chlorine-based disinfectants may significantly reduce the performance and the working life of a coated material.

Type of Cleaning	Parts to be cleaned
Routine Cleaning and Disinfection	<ul style="list-style-type: none"> ■ exposed mattress parts ■ exposed SCU parts
Full Cleaning and Disinfection	<ul style="list-style-type: none"> ■ exposed mattress parts ■ exposed SCU parts ■ internal parts of mattress ■ internal parts of cover

14.1 Routine Cleaning and Disinfection

Cleaning the mattress:

- ▶ Check mattress cover top for any signs of damage.
Replace or repair and completely disinfect mattress cover top if damaged.
- ▶ Check inside of mattress cover top for signs of liquid ingress.
Replace or clean and completely disinfect mattress cover top if damp inside.
- ▶ Leave mattress cover on mattress.
- ▶ Clean with 60°C warm water and cleaning detergent.
- ▶ Rinse mattress with cold water.

- ▶ Let mattress dry or wipe dry.
- ▶ Wipe mattress with disinfectant.
- ▶ Rinse mattress with cold water.
- ▶ Let mattress dry or wipe dry.

Cleaning the SCU:

- ▶ Wipe SCU with disinfectant.
- ▶ Let SCU dry or wipe dry.

14.2 Full Cleaning and Disinfection

Cleaning the mattress:

- ▶ Deflate mattress and remove cover (see Removing the Mattress Cover).
- ▶ Check mattress cover top and base for any signs of damage.
Replace or repair and completely disinfect mattress cover top and base if damaged.
- ▶ Check mattress cover top and base for signs of liquid ingress.
Replace or clean and completely disinfect mattress cover top and base if damp inside.
- ▶ Clean all mattress cells and pipes with 60°C warm water and cleaning detergent.
- ▶ Rinse mattress with cold water.
- ▶ Let mattress dry air dry or wipe dry.
- ▶ Wipe mattress with disinfectant.
- ▶ Rinse mattress with cold water.
- ▶ Let mattress dry air dry or wipe dry.

Cleaning the mattress cover:

- ▶ Remove cover (see Removing the Mattress Cover).
- ▶ If machine washing mattress top/base covers, the temperature should be raised during the wash cycle, to 65°C/149°F, for 10 -15 minutes, or 71°C/160° F, for 3 - 10 minutes, using hospital approved detergents and rinsing agents.

NOTE Maximum wash temperature 75°C/167°F.

- ▶ Dry cover in tumble dryer at low temperature.

Cleaning the air pipe:

- ▶ Wipe air pipe with cleaning agent or disinfectant.
- ▶ Let air pipe dry.

Cleaning the SCU:

- ▶ Remove filter.
- ▶ Wipe SCU and filter with disinfectant.
- ▶ Let SCU and filter dry.
- ▶ Reinsert filter.

14.3 Removing the Mattress Cover

- ▶ Carefully open zipper under side skirt of mattress cover on foot end of mattress.
- ▶ Remove top part of mattress cover.
- ▶ Undo corner toggles holding comforter cover and remove comforter cover.
Inspect comforter cover and clean if necessary.
- ▶ Undo toggles holding top deck to foam base.
- ▶ Undo plastic clip next to air pipe inlet on base cover holding foam base to cover.
- ▶ Remove bottom part of mattress cover.

After cleaning the mattress cover:

- ▶ Reinstall mattress cover by reversing the process described above.
- ▶ Make sure all toggles are put back in their respective holes.

General guidance – Slippy Cover

WARRANTY Due to the nature and MVP (Moisture Vapor Permeability) rating of the Slippy Cover Material, the Warranty is 1 year. Chemical damage caused by using aggressive or incorrect cleaners will not be accepted under the warranty

LIFESPAN Typically 50 cleaning cycles in accordance with manufacturers' instructions.

- ▶ Do not use any strong acids or alkalines, (optimum pH range 6 – 8. Do not exceed pH of 9).
- ▶ Use only hospital-approved cleaners suitable for use on coated textiles and observe local directives concerning infection control.
- ▶ Do not use abrasive powders, steel wool, or other material and cleaning agents that might damage the mattress. Do not scrub mattress surface. Do not allow mechanical damage to occur, (e.g. Needle stick, scalpel/scissors cuts).
- ▶ Never use any corrosive or caustic detergents. Do not use cleaners containing Peroxide.
- ▶ Never use detergents that deposit calcium carbonate.
- ▶ Never use detergents with solvents that might affect the structure and consistency of the plastics (benzene, toluene, acetone, phenol, etc.).
- ▶ Use only hospital-approved cleaners and observe local directives concerning infection control.
- ▶ Always rinse with water after cleaning and dry thoroughly before use.
- ▶ Always refer to wash label and user guide for each system, as there may be specific instructions for the cover being used.

Mattress parts to be cleaned	Recommended Cleaning Agents (General cleaning)
Top Cover High MVP (Moisture Vapor Permeable) Material Slippy Mattress Cover Top	Standard hospital detergents or cleaners suitable for use on coated textiles, as described above. Chlorine based disinfectants containing up to 1000 ppm (0.1%) available Chlorine, followed by rinsing with water and drying thoroughly before use.
	Decontamination: Blood spills/Clostridium difficile etc Chlorine based wipes containing up to 5500 ppm (0.55%) available Chlorine (e.g. Clinell Clorox wipes). Dwell time on surface at 5500 ppm of 3 minutes, followed by rinsing with water and drying thoroughly before use.

Due to the variety of laundry equipment, chemicals and conditions in use, it is the customers' responsibility to ensure compliance with manufacturers detailed cleaning instructions.

As stated above, after application of a suitable cleaner and after a suitable dwell time, it is essential that articles be thoroughly rinsed and dried before use. (Even if the cleaner instructions say that this is not required). This prevents a build up of chemicals on the mattress surface which could be reactivated during use and affect biocompatibility. Wet or damp PU (Polyurethane) surfaces are more prone to mechanical damage than when dry. The High MVP Coating may swell and change appearance during cleaning. This will recover after being thoroughly dried. (Air dry. Do not wipe aggressively). Before further use, the cover must be fully dry.

14.4 Machine Washing (Hi-MVP Slippy Mattress Cover)

Machine wash top cover using hospital approved, detergent & rinsing agents. The detergent must not contain chlorine based bleach or peroxide. In order to kill bacteria, during the wash cycle the water temperature must be raised to 71 degrees C (160 degrees F) for 3 minutes, or 10 minutes at 65 degrees C (149 degrees F). Dry cover in tumble dryer at low temperature setting.

NOTE Constant use of high concentrations of Chlorine-based cleaners, or high PH value cleaners, may significantly reduce the performance and the working life of a coated material.

NOTE Covers that have physical damage that would allow fluids to penetrate inside the mattress cover must not be re-used but disposed of as clinical waste.

NOTE On High Vapour Permeable covers, vapour from chemicals with small molecules can occasionally diffuse through the polyurethane membrane in a similar manner to water vapour. Any staining on the inside of the cover caused by such an occurrence is not due to any loss of liquid / microbial barrier properties of the fabric, and being cosmetic only, should not be treated as a cover failure as replacement is not required.

15 Troubleshooting (OptiCare)



DANGER!

Risk of mortal injury due to electric shock!

- ▶ If a fault occurs, have the electric motor, power box or other electrical parts repaired by qualified personnel exclusively.
- ▶ Do not open the protective covers of the electric motor or the power box.



WARNING!

Risk of injury due to lack of support!

If the OptiCare integrated mattress is empty so that the patient is lying directly on the foam base, and it is not possible to solve the problem by following the troubleshooting instructions:

- ▶ Move patient onto a suitable support surface as quickly as possible.

16 Maintenance (OptiCare)



WARNING!

Risk of injury when working on the mattress replacement system!

- ▶ Ensure that the mattress replacement system is disconnected from the mains power prior to installation, putting into service, maintenance and deinstallation.



WARNING!

Risk of injury due to defective mattress replacement system!

- ▶ Have a defective mattress replacement system repaired immediately.
- ▶ If the defect cannot be repaired, do not use the mattress replacement system.



CAUTION!

Material damage due to incorrect maintenance!

- ▶ Ensure that maintenance is performed exclusively by manufacturer's customer service or by authorised service personnel certified by the manufacturer.
- ▶ If the defect cannot be repaired, do not use the mattress replacement system.

16.1 Regular maintenance

- ▶ Perform regularly visual check of the product (with delivery note if necessary).
- ▶ Ask service department of the manufacturer for addition of the original spare parts if some product parts are missing.
- ▶ Ask service department of the manufacturer for replacement of any damaged product parts by the original spare parts.
- ▶ Check inside and outside of mattress and outside of SCU for mechanical damage and signs of severe wear and tear.
- ▶ Check if mattress and SCU are working properly.
- ▶ Check external air filter in side of SCU for dust and dirt. If dust or dirt is visible, replace filter.

16.2 Spare Parts

The serial label is located on the SCU and on the mattress. The serial labels contain information for claims and ordering replacement parts.

Information about spare parts is available from:

- Manufacturer's customer service
- Sales department

16.3 Safety Technical Checks



WARNING!

Risk of injury due to incorrect safety technical checks!

- ▶ Ensure that safety technical checks are performed exclusively by manufacturer's customer service or by authorised service personnel certified by the manufacturer.
- ▶ Ensure that the safety technical checks are recorded in the service and maintenance log.

Safety technical check of the mattress replacement system must be performed at least once every 12 months.

The procedure for performing the safety technical check is stipulated in EN 62353:2014.

NOTE On request, the manufacturer will provide service documentation (e.g. circuit diagrams, component part lists, descriptions, calibration instructions etc.) for service personnel for the repair of ME equipment designated by the manufacturer as repairable by service personnel.

17 Disposal (OptiCare)

17.1 Environment Protection

The company LINET® is aware of the importance of environmental protection for future generations. Within this company the environmental management system is applied in accordance with the internationally agreed standard ISO 14001. The compliance with this standard is annually tested by the external audit executed by an authorised company. Based on the Directive No. 2002/96/EC (Directive **WEEE** - Waste, Electric and Electronic Equipments) the company LINET, s. r. o. is registered in the List of Electric and Electronic Equipment Producers (**Seznam výrobců elektrozařízení**) on the Ministry of the Environment of the Czech Republic (Ministerstvo životního prostředí).

Materials used in this product are not environmentally hazardous. LINET® products meet valid requirements of national and European legislation in the areas of **RoHS** and **REACH**, so they do not contain any prohibited substances in excess quantities. None of the wooden parts is made of tropical wood (such as mahogany, rosewood, ebony, teak etc.) or made of timber from the Amazon region or from similar rainforests. Product noise (sound pressure level) meets requirements of the regulations for the protection of public health against undesirable effects of noise and vibration in protected interior spaces of buildings (according to standard IEC 60601-2-52). Used packaging materials are in accordance with requirements of the Packaging Act (**Zákon o obalech**). For disposal of packaging materials after installation of products contact your sales representative or manufacturer's customer service about the possibility of a free take-back of packaging through an authorized company (more details on www.linnet.cz).

17.2 Disposal

The main objective of the obligations arising from the European Directive No. 2012/19/EU on Waste, Electric and Electronic Equipments (nationally regulated in Act No. 185/2001 Coll. as amended. On Waste and in Decree of the Ministry of the Environment No. 352/2005 Coll. as amended), is to increase the re-use, material recovery and recovery of electric and electronic equipment at the required level, thereby avoiding the production of waste and thereby avoiding the possible harmful effects of hazardous substances contained in electric and electronic equipment on human health and the environment. LINET® electric and electronic equipments that have a built-in battery or accumulator are designed so that the used batteries or accumulators can be safely removed by LINET® qualified service technicians. There is an information about its type on the built-in battery or accumulator.

17.2.1 Within Europe

To dispose of the electric and electronic equipment:

- ▶ The electric and electronic equipment must not be disposed of as household waste.
- ▶ Dispose of this equipment at designated collection points or take-back points.

To dispose of the other equipment:

- ▶ The equipment must not be disposed of as household waste.
- ▶ Dispose of this equipment at designated collection points or take-back points.

LINET® participates in a collective system with take-back company REMA System (see www.remasystem.cz/sberna-mista/). By bringing electric and electronic equipment to a take-back point, you participate in recycling and you save primary raw material resources while protecting your environment from effects of unprofessional disposal.

17.2.2 Outside Europe

- ▶ Dispose of the product or its components in accordance with local laws and regulations!
- ▶ Hire an approved waste disposal company for disposal!

18 Warranty (OptiCare)

LINET® will only be held responsible for the safety and reliability of products that are regularly serviced, maintained and used in accordance with the safety guidelines.

Should a serious defect arise that cannot be repaired during maintenance:

- ▶ Do not continue to use the bed.

Warranty duration is subject to individual purchasing agreements with a minimum length of 12 months.

The warranty covers all material and manufacturing-related failures and errors. Failures and errors caused by incorrect use and external effects are not covered. Justified complaints will be fixed free of charge during the warranty period. Proof of purchase, with the date of purchase, is required for all warranty service.

19 Standards and Regulations (OptiCare)

19.1 OptiCare

The OptiCare integrated mattress replacement system complies with the following standards:

- IEC 60601-1
- CAN/CSA C22.2 NO. 60601-1
- ANSI/AAMI ES60601-1
- IEC 60601-1-2
- IEC 60601-1-6
- ISO 10993-5
- ISO 10993-10

19.2 Manufacturer

The manufacturer adheres to a certified quality management system in compliance with the following standards:

- ISO 9001
- ISO 14001
- ISO 13485
- MDSAP (Medical Device Single Audit Program)